

# Safe Sailing

SkyLine Combi Ovens

Brochure, Range Overview, Accessories



# Serenity wherever you are

Champions of safety, stability and high performance, Electrolux Professional marine version SkyLine Ovens guarantee the operator safe and ergonomic ease-of-use even in extreme marine environments.



**Double-step door** opening for safe operations and door stopper to secure the door when open, even during the roughest sea conditions.



**Tray racks equipped with tray stoppers** to secure trays and guarantee safe operations.

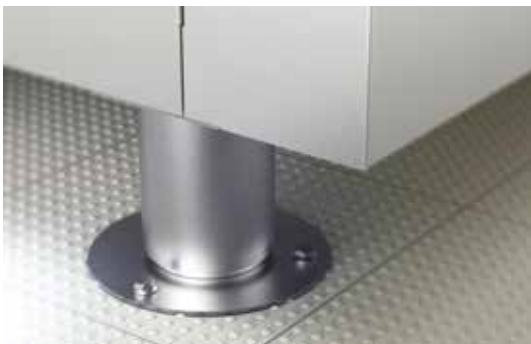

**Stainless steel flanged feet** to fix the oven to the floor or to a counter-top



**Double step door opening** for safe operations.



## USPH Compliant.

Electrolux Professional appliances guarantee high level of hygiene in accordance to USPH standard.

**Specifically designed installation accessories, such as stacking and wall sealing kits, ensure a high level of hygiene.**

# A safe harbour with our ovens

With SkyLine you can rely on a heavy-duty-designed combi oven, fearless of the most challenging galley conditions at sea and guaranteeing efficient food production.



## Robust and Reliable Solutions



Handy and highly resistant door



Sturdiness from the ground up



Designed for non-stop-operations



LED lights on the door

reproduce the ideal natural brightness to let you check the cooking level of your food with no need to open the door.\*



Tested to a higher standard

this unit will ensure the elevated levels of vibration and shock in a Marine application.

\*Triple-glass door is available as optional for more insulation and extra savings in energy consumption.

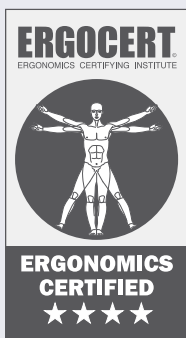

Experience **4 stars**



Compliance with ergonomic principles  
Designed with you in mind

Evidence-based anthropometric & biomechanical compliance  
Reduced risk of injury

Evidence-based usability  
The culmination of years of professional studies and expertise

Human-Centered Design  
To make cooking simple and stress-free

**FIRST**  
in the industry

**REGISTERED DESIGN\*\***

\*\* SkyLine Oven design EM003143551 and related family

# Touch the sky, it's easy

Super-intuitive touch screen interface lets you customize your SkyLine oven to your needs, for errors-free operations. Set your cooking preferences to guarantee consistent high quality results.

## Manual mode

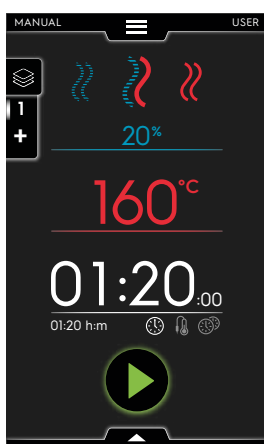

### Ideal for demanding chefs

Master to detail your own cooking cycles by selecting your preferred cooking parameters in terms of humidity %, food core temperature, cavity temperature, time, fan speed level and much more.

## Programs mode

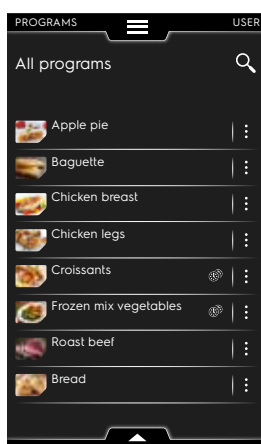

### Ideal for repeat menus

Save your programs and get the same high standard results anywhere in the world!

Create Programs Categories, MultiTimer Programs (for mixed loads) in order to organize the preparation of your menus to perfection, day by day.

## Automatic mode

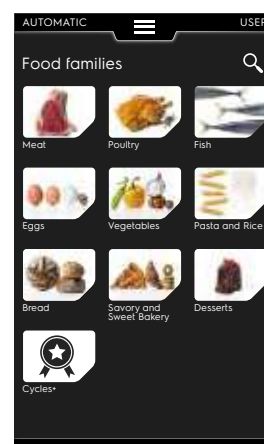

### Ideal for saving time and money

Explore the variety of cooking techniques and recipes of the Automatic Cycles and Cycles+.

Technology is what guarantees you obtain consistent top results over time. No matter if it's for single or batch preparations, SkyLine automatically understands the load and adjusts cooking parameters consequently.

Quality and Productivity can go hand-in-hand!

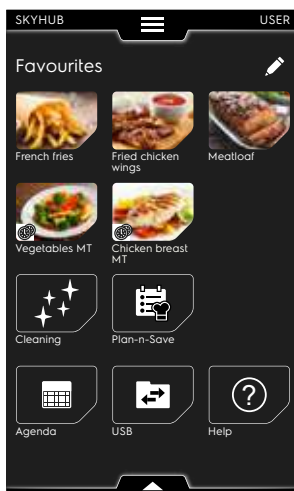

### One page. One touch.

Thanks to the SkyHub you can place the most used cooking cycles and functions on one page and even organize them in folders. SkyHub guarantees easy access even to unskilled employees.



# Perfect cleaning, less consumption



## Smart savings and sustainably built-in

### Committed to sustainability

Our even more efficient, high performance SkyLine Ovens are designed to help you work better, save money and reduce your environmental footprint. That is the Electrolux Professional commitment to sustainability.

### Energy star certification

Rigorously tested and certified in compliance with the most stringent international standards, SkyLine Ovens are also the only ovens in the world to have 4-star certification for ergonomics and usability.



Scan to see the models Energy Star listed



### Energy, water and detergent consumption are reduced

to the lowest possible in the **4 standard cycles** (54 to 180 min) and you can save even more by choosing eco-friendly Green Spirit cycles.

Solid detergent is safe to handle and very efficient.

### Use MyPlanner

to schedule your cleaning routines based on the operating hours.

### SkyLine won't be left uncleaned.

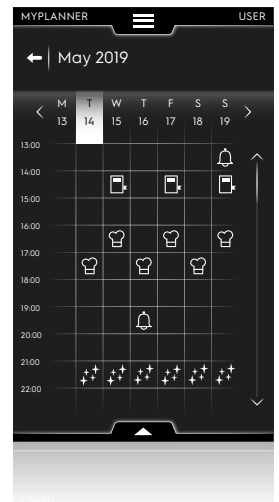

Thanks to **SkyClean** your oven can be easily cleaned to perfection, ready for the next preparation!



**C22 Cleaning tab**  
100 tabs bucket;  
65 gr. each

**C25 Rinse & Descale Tab**  
50 tabs buckets;  
30 gr. each



Longer life and top performance of Skyline Ovens only with phosphate free Electrolux Professional chemicals.\*

\* The use of Electrolux Professional original chemicals ensures ideal performance and durability of your oven.

# Non-stop productivity

Main Galley



Portions per full load:



Roast beef: up to 450\*



Steamed broccoli: up to 1000\*



Boiled rice: up to 75\*



Croissants: up to 320\*

SkyLine assists you during all your bakery preparations through the **Prove&Bake functions**.

No matter which dough you are preparing and no matter which browning level you want to obtain, your SkyLine will accurately regulate all cooking parameters in order to obtain results with just the right moisture in the inside and perfect crispiness on the outside.

\* Productivity data is calculated based on automatic cycles under standard conditions. Actual performance may vary depending on the specific recipe, product, or operational settings.

Easy to navigate, even without experience, while maintaining high productivity.

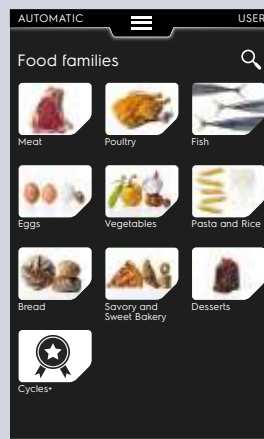

Automatic mode

The best way to increase efficiency in your kitchen

Automatic cycles guide you through the preparation of multiple recipes in a completely automatic way, with a special focus on food safety and energy consumption.

# Banqueting without compromise

Main  
Galley



Experience smooth operations with a full range of accessories for banqueting and handling systems designed to perfectly serve high quality food using SkyLine solution for banqueting.



 **Maximise  
kitchen efficiency**

 **Standardise  
portions**

 **Reduce  
kitchen footprint**

 **Reduce food  
wastage**

 **Ensure  
consistency of  
each plate**

 **Food quality  
control and consistency  
(HACCP monitoring)**

 **Lambda  
sensor as standard**

in the ovens with boiler.  
Precise real-time  
measurement and control  
over humidity in the Oven  
chamber for every type of  
food and size of load.

## Customize your User Interface with SkyHub!

You can organize your food production in folders and have easy and direct access to the most used functions in one place.

## Lock environments

Some specific environments or functions can be hidden and access can even be locked with a password. This way operators can only see what they need, avoiding mistakes and saving time during training sessions.



Thanks to  
MyPlanner  
you can set  
all activities  
that need to  
be done.

Schedule all operations in the calendar and set reminders to be sure the best possible workflow is followed.

# Designed by Chefs for Chefs

Main Galley



State of the art functions mean the very best solutions. Our hands-on chefs have helped design a unique product to satisfy all your needs for flexibility in your daily production.

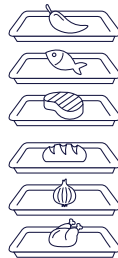

## Stress-free rush hours



Smoother workflow with easy planning and management of multiple cooking cycles

Improve flexibility by planning and managing multiple cooking cycles with MultiTimer during rush hours (set up to 20 timers).

Assign a different timer to a specific food typology for easy recognition.

## MultiTimer function

The SkyLine PremiumS Combi Oven allows you to prepare breakfast buffets to perfection in no time! All at once! Save time without compromising quality.

With ongoing production of multiple food at the same time you can drastically reduce excess of production for your buffet.



Scan to watch the brioche bread proving & baking cycle

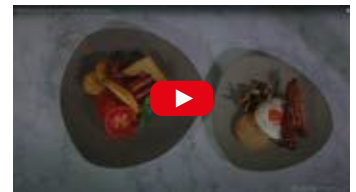

Scan to watch the perfect English breakfast being cooked

## Expand your horizons & Save time with Cycles+



### A-la-carte restaurant and room service

SkyLine makes sure your restaurant is always available for the best room service! At any time, for every need...

for tasty midnight snacks or on demand delicatessen.



### Overnight cooking

Perform long lasting cooking cycles during the night to optimize daily work



### Low temperature cooking

Juicy and perfectly cooked meat with minimum weight loss and max profitability



### Static combi

For preparations using low ventilation and low temperature. Ideal for traditional recipes such as beef bolognese ragù, goulash, fish soups etc



Proving



Dehydration



Fresh pasta pasterurization



# SkyLine family

Scan to see the SkyLine full range in **augmented reality**



Choose the perfect partner to start expanding your cooking horizons.



**6GN 1/1**

External dimensions (wx-dxh) 867x775x808 mm  
Electrical power - 11 kW



**6GN 2/1**

External dimensions (wx-dxh) 1090x971x808 mm  
Electrical power - 21,4 kW



**10GN 1/1**

External dimensions (wx-dxh) 867x775x1058 mm  
Electrical power - 19 kW



**10GN 2/1**

External dimensions (wx-dxh) 1090x971x1058 mm  
Electrical power - 37,4 kW



**20GN 1/1**

External dimensions (wx-dxh) 911x865x1794 mm  
Electrical power - 37,7 kW



**20GN 2/1**

External dimensions (wx-dxh) 1162x1067x1794 mm  
Electrical power - 65,4 kW

## Range overview

### SkyLine Premium<sup>S</sup>

- Touch panel
- Boiler
- Triple-glass door\*

### SkyLine Premium

- Digital panel
- Boiler
- Triple-glass door\*

### SkyLine Pro<sup>S</sup>

- Touch panel
- Steam injection
- Triple-glass door\*

### SkyLine Pro

- Digital panel
- Steam injection
- Triple-glass door\*

# OnE Connected, your digital assistant

OnE Connected helps you get top performance from your Electrolux Professional solutions. With digital solutions provided with your connected appliances you can be in full control, improve efficiency & sustainability, maximize uptime of your appliances and ensure food safety and consistency quality in your entire operations



## Be in Control

### 24/7 real time monitoring

OnE Connected gives you remote control over your operations across the globe in just one click by tracking the your appliances' status and analysis and receiving critical alarms in real time.



## Non-stop operations

### Increase equipment uptime

OnE Connected helps you to track the alarms of your appliances, to ensure maximum uptime while reducing your costs for unexpected breakdowns.

OnE Connected knows when to alert you so **you can react quickly and increase uptime**. For the best service ever, the same message can be sent to the Service Partner of your choice.



## Improve Efficiency & Sustainability

### Ensure efficient & sustainable operations

OnE Connected helps your efficiency & sustainability journey. Monitor the valuable analytics data of your operations to improve efficiency and track the consumption of your connected oven to detect anomalies and take actions accordingly.



## Ensure consistent menu day after day

With OnE Connected, you can create, store and share recipes directly with your appliances.

Sending recipes from your cloud library to connected appliances is a great way to improve fleet management ensuring consistent menu across your locations.



## Ensure Food Safety

Shouldn't we guarantee everyone safe and healthy meals?

Connectivity also means safety. **Automatic digital HACCP documentation** will provide compulsory evidence of safe cooking processes and quality, saving you time and paperwork. With data at your fingertips, you can make adjustments where needed to ensure your processes are respecting the hygiene and food safety requirements.



# Essentia Teamed to serve you. Anytime, anywhere

Essentia is **the heart of superior Customer Care**, a dedicated service that ensures your competitive advantage. Essentia provides you with the support you need and takes care of your processes with a **reliable service network**, a range of tailor-made exclusive services and innovative technology.

You can count on more than **2,200 authorized service partners**, **10,000 service engineers** in more than **149 countries**, and over **170,000 managed spare parts**.

## Service network, always available

We stand ready and committed to support you with a **unique service network** that makes **your work-life easier**.

## Keep your equipment performing

Undertaking correct maintenance in **accordance with Electrolux Professional Manuals** and recommendations is essential to avoid unexpected issues. **Electrolux Professional Customer Care** offers a number of **tailor made service packages**. For more information contact your preferred Electrolux Professional **Authorized Service Partner**.

You can rely on the quick dispatch of original Accessories & Consumables, rigorously tested by Electrolux Professional experts to ensure **durability and performance of your equipment**, together with **user safety**.



Find  
out more





# SkyLine Ovens Range Overview

<b>SkyLine Premium<sup>s</sup></b>	<b>14</b>
6 GN 1/1 electric	15
6 GN 2/1 electric	15
10 GN 1/1 electric	16
10 GN 2/1 electric	16
20 GN 1/1 electric	17
20 GN 2/1 electric	17
<b>SkyLine Premium</b>	<b>18</b>
6 GN 1/1 electric	19
6 GN 2/1 electric	19
10 GN 1/1 electric	20
10 GN 2/1 electric	20
20 GN 1/1 electric	21
20 GN 2/1 electric	21
<b>SkyLine Pro<sup>s</sup></b>	<b>22</b>
6 GN 1/1 electric	23
6 GN 2/1 electric	23
10 GN 1/1 electric	24
10 GN 2/1 electric	24
<b>SkyLine Pro</b>	<b>25</b>
6 GN 1/1 electric	26
6 GN 2/1 electric	26
10 GN 1/1 electric	27
10 GN 2/1 electric	27

# SkyLine Premium<sup>s</sup>

Touch panel  
Boiler



## Touch panel

Super-intuitive, simple-to-learn and -use and customizable touch screen interface designed to make life easy. Color-blind friendly. Available in over 30 different languages.



## 101 humidity settings

Add variety to your cooking with 101 humidity settings from 0% to 100% boiler-generated steam, with automatic exhaust valve opening for extra crispy food.



## OnE connectivity

### ready

SkyLine Premium<sup>s</sup> connectivity gives real time access to your appliance from any smart device.



## Green Version

Triple-glass door reduces energy consumption thanks to higher insulation.



## Program mode

Save, organize into categories, and share up to **1.000 recipes** via USB or OnE connectivity.



## OptiFlow

Perfect, even cooking results thanks to revolutionary high-tech **OptiFlow** air distribution system which guarantees uniform heat distribution.



## 6-sensor probe as standard

Precise measurement of the exact core temperature of your food.



## Lambda sensor as standard

Precise real-time measurement and control over the humidity in the Oven chamber.



## An extra effortless benefit

Stress-free efficiency and productivity with **SkyDuo**. Anticipating your needs with the self-intuitive connection between SkyLine Premium<sup>s</sup> Ovens and SkyLine Chill<sup>s</sup> and viceversa. The appliances guide you through the Cook&Chill process.



## Advanced features

Simplify your life and make your workflow leaner by personalizing your **SkyHub homepage** with your favorite functions. Use **MyPlanner** to plan your daily work and receive personalized alerts for your tasks. **Plan-n-Save** organizes your loads in the most time- and energy-efficient way possible.

**FIRST**  
in the industry

for  
**Plan-n-Save**



## SkyClean

Cut your cleaning costs up to 15%. Flawless cleaning results, **green functions** and **automatic boiler descaling**. Flexible choice of 3 different chemicals to serve you better: **solid, liquid or 85% biodegradable enzymatic**.

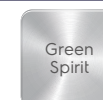
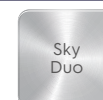

# SkyLine Premium<sup>S</sup> Combi Boiler Oven

## Touch 6GN1/1 electric



	227720	227710
Number of grids	6	6
Runner pitch - mm	67	67
External dimensions - mm		
width	867	867
depth	775	775
height	808	808
Electric power - kW	11.5	11.8
Electric amperage - A	15.6	17
Electrical connection	440V 3 50/60 H	380-415V 3 50/60 Hz
USPHS	•	•

# SkyLine Premium<sup>S</sup> Combi Boiler Oven

## Touch 6GN2/1 electric



	227721	227711
Number of grids	6	6
Runner pitch - mm	67	67
External dimensions - mm		
width	1090	1090
depth	971	971
height	808	808
Electric power - kW	22.3	22.9
Electric amperage - A	29.6	32.1
Electrical connection	440V 3 50/60 Hz	380-415V 3 50/60 Hz
USPHS	•	•

# SkyLine Premium<sup>S</sup> Combi Boiler Oven

## Touch 10GN1/1 electric



	227722	227712
Number of grids	10	10
Runner pitch - mm	67	67
External dimensions - mm		
width	867	867
depth	775	775
height	1058	1058
Electric power - kW	19.8	20.3
Electric amperage - A	26	28.3
Electrical connection	440V 3 50/60 Hz	380-415V 3 50/60 Hz
USPHS	•	•

# SkyLine Premium<sup>S</sup> Combi Boiler Oven

## Touch 10GN2/1 electric



	227723	227713
Number of grids	10	10
Runner pitch - mm	67	67
External dimensions - mm		
width	1090	1090
depth	971	971
height	1058	1058
Electric power - kW	39.0	40.1
Electric amperage - A	50.8	55.3
Electrical connection	440V 3 50/60 Hz	380-415V 3 50/60 Hz
USPHS	•	•



# SkyLine Premium<sup>S</sup> Combi Boiler Oven

## Touch 20GN1/1 electric



	227724	227714
Number of grids	20	20
Runner pitch - mm	63	63
External dimensions - mm		
width	911	911
depth	865	865
height	1794	1794
Electric power - kW	39.3	51.5
Electric amperage - A	40.4	56.0
Electrical connection	440V 3 50/60 Hz	380-415V 3 50/60 Hz
USPHS	•	•

# SkyLine Premium<sup>S</sup> Combi Boiler Oven

## Touch 20GN2/1 electric



	227725	227715
Number of grids	20	20
Runner pitch - mm	63	63
External dimensions - mm		
width	1162	1162
depth	1067	1067
height	1794	1794
Electric power - kW	68.3	70.2
Electric amperage - A	88.8	96.7
Electrical connection	380-415V 3N 50/60 Hz	380-415V 3N 50/60 Hz
USPHS	•	•

# SkyLine Premium

Digital panel

Boiler



## Program mode

Save and share your programs via USB or OnE connectivity. 100 free programs and 4 cooking phases.



## OptiFlow

Perfect, even cooking results thanks to revolutionary high-tech **OptiFlow** air distribution system which guarantees uniform heat distribution.



## Food core temperature control probe

Exact temperature reading with single sensor probe and for extra precision choose the optional **6-sensor probe**.



## Lambda sensor as standard

Precise real-time measurement and control over humidity in the Oven chamber for every type of food and size of load.



## SkyClean

Flawless cleaning results and **integrated boiler descaling**. Flexible choice of 3 different chemicals to serve you better: **solid, liquid or 85% biodegradable enzymatic**.



## Digital panel

**Digital panel** with unique light-guided selection simplifies every task.



## 11 humidity settings

Add variety to your cooking with **11 humidity settings** from 0% to 100% boiler-generated steam, with automatic exhaust valve opening for extra crispy food.



## OnE connectivity ready

SkyLine Premium connectivity gives **real time access** to your appliance from any smart device.

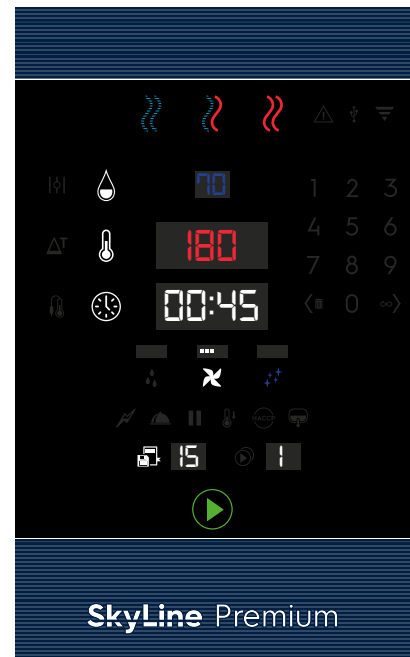

SkyLine Premium



Lambda sensor

Sky Clean

Human-Centered Design

**FIRST**  
in the industry

# SkyLine Premium Combi Boiler Oven

## Digital 6GN1/1 electric



	227820	227810	227830
Number of grids	6	6	6
Runner pitch - mm	67	67	67
External dimensions - mm			
width	867	867	867
depth	775	775	775
height	808	808	808
Electric power - kW	11.5	11.8	11.1
Electric amperage - A	15.6	17	13.8
Electrical connection	440V 3 50/60 H	380-415V 3 50/60 Hz	480V 3 60 Hz
USPHS	•	•	•

# SkyLine Premium Combi Boiler Oven

## Digital 6GN2/1 electric



	227821	227811
Number of grids	6	6
Runner pitch - mm	67	67
External dimensions - mm		
width	1090	1090
depth	971	971
height	808	808
Electric power - kW	22.3	22.9
Electric amperage - A	29.6	32.1
Electrical connection	440V 3 50/60 H	380-415V 3 50/60 Hz
USPHS	•	•

# SkyLine Premium Combi Boiler Oven

## Digital 10GN1/1 electric



	227822	227812	227832
Number of grids	10	10	10
Runner pitch - mm	67	67	67
External dimensions - mm			
width	867	867	867
depth	775	775	775
height	1058	1058	1058
Electric power - kW	19.8	20.3	19.0
Electric amperage - A	26.0	28.3	22.9
Electrical connection	440V 3 50/60 Hz	380-415V 3 50/60 Hz	480V 3 60 Hz
USPHS	•	•	•

# SkyLine Premium Combi Boiler Oven

## Digital 10GN2/1 electric



	227823	227813
Number of grids	10	10
Runner pitch - mm	67	67
External dimensions - mm		
width	1090	1090
depth	971	971
height	1058	1058
Electric power - kW	39.0	40.1
Electric amperage - A	50.8	55.3
Electrical connection	440V 3 50/60 Hz	380-415V 3 50/60 Hz
USPHS	•	•

# SkyLine Premium Combi Boiler Oven

## Digital 20GN1/1 electric



	227824	227814
Number of grids	20	20
Runner pitch - mm	63	63
External dimensions - mm		
width	911	911
depth	865	865
height	1794	1794
Electric power - kW	39.3	51.5
Electric amperage - A	40.4	56.0
Electrical connection	440V 3 50/60 Hz	380-415V 3 50/60 Hz
USPHS	•	•

# SkyLine Premium Combi Boiler Oven

## Digital 20GN2/1 electric



	227825	227815
Number of grids	20	20
Runner pitch - mm	63	63
External dimensions - mm		
width	1162	1162
depth	1067	1067
height	1794	1794
Electric power - kW	68.3	70.2
Electric amperage - A	88.8	96.7
Electrical connection	440V 3 50/60 Hz	380-415V 3N 50/60 Hz
USPHS	•	•

# SkyLine Pro<sup>S</sup>

Touch panel

Steam injection



## Touch panel

Super-intuitive, simple-to-learn and -use touch screen interface designed to make life easy. Adapted for color blindness. Available in over 30 different languages.



## 11 humidity levels

Add variety to your cooking with **11 humidity settings** from 0% to 100% and high efficiency instant steam with automatic exhaust valve opening for extra crispy food.



## OnE connectivity

ready

SkyLine Pro<sup>S</sup> connectivity gives real time access to your appliance from any smart device.



## Program mode

Save, organize into categories, and share up to **1.000 recipes** via USB or OnE connectivity.



## OptiFlow

Perfect, even cooking results thanks to revolutionary high-tech **OptiFlow** air distribution system which guarantees uniform heat distribution.



## Food core temperature control probe

Exact temperature reading with single sensor probe and for extra precision choose the optional **6-sensor probe**.



## Advanced features

Simplify your life and make your workflow leaner by personalizing your **SkyHub homepage** with your favorite functions. Use **MyPlanner** to plan your daily work and receive personalized alerts for your tasks.



## SkyClean

Flawless cleaning results, **green functions**. Flexible choice of 3 different chemicals to serve you better: **solid, liquid or 85% biodegradable enzymatic**.

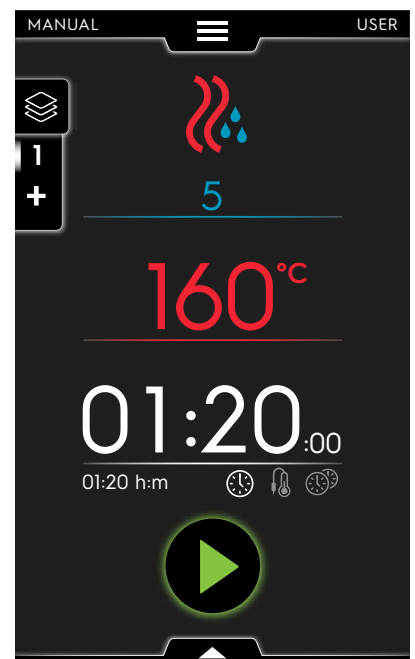

# SkyLine Pro<sup>S</sup> Combi Boilerless Oven

## Touch 6GN1/1 electric



	227620	227610
Number of grids	6	6
Runner pitch - mm	67	67
External dimensions - mm		
width	867	867
depth	775	775
height	808	808
Electric power - kW	11.5	11.8
Electric amperage - A	15.6	17
Electrical connection	440V 3 50/60 H	380-415V 3 50/60 Hz
USPHS	•	•

# SkyLine Pro<sup>S</sup> Combi Boilerless Oven

## Touch 6GN2/1 electric



	227621	227611
Number of grids	6	6
Runner pitch - mm	67	67
External dimensions - mm		
width	1090	1090
depth	971	971
height	808	808
Electric power - kW	22.3	22.9
Electric amperage - A	29.6	32.1
Electrical connection	440V 3 50/60 H	380-415V 3 50/60 Hz
USPHS	•	•

# SkyLine Pro<sup>S</sup> Combi Boilerless Oven

## Touch 10GN1/1 electric



	227622	227612
Number of grids	6	6
Runner pitch - mm	67	67
External dimensions - mm		
width	867	867
depth	775	775
height	1058	1058
Electric power - kW	19.8	20.3
Electric amperage - A	26.0	28.3
Electrical connection	440V 3 50/60 Hz	380-415V 3 50/60 Hz
USPHS	•	•

# SkyLine Pro<sup>S</sup> Combi Boilerless Oven

## Touch 10GN2/1 electric



	227923	227913
Number of grids	10	10
Runner pitch - mm	67	67
External dimensions - mm		
width	1090	1090
depth	971	971
height	1058	1058
Electric power - kW	36.9	37.9
Electric amperage - A	48.2	52.4
Electrical connection	440V 3 50/60 Hz	380-415V 3 50/60 Hz
USPHS	•	•



# SkyLine Pro

Digital panel

Steam injection



## Program mode

Save and share your programs via USB or OnE connectivity. 100 free programs and 4 cooking phases.



## Food core temperature control probe

Exact temperature reading with single sensor probe and for extra precision choose the optional 6-sensor probe.



## OptiFlow

Perfect, even cooking results thanks to revolutionary high-tech **OptiFlow** air distribution system which guarantees uniform heat distribution.



## SkyClean

Flawless cleaning results. Flexible choice of 3 different chemicals to serve you better: **solid, liquid or 85% biodegradable enzymatic.**



## Digital panel

**Digital panel** with unique light-guided selection simplifies every task.



## 11 humidity levels

Add variety to your cooking with **11 humidity settings** from 0% to 100% and high efficiency instant steam with automatic exhaust valve opening for extra crispy food.



## OnE connectivity ready

SkyLine Pro connectivity gives real time access to your appliance from any smart device.

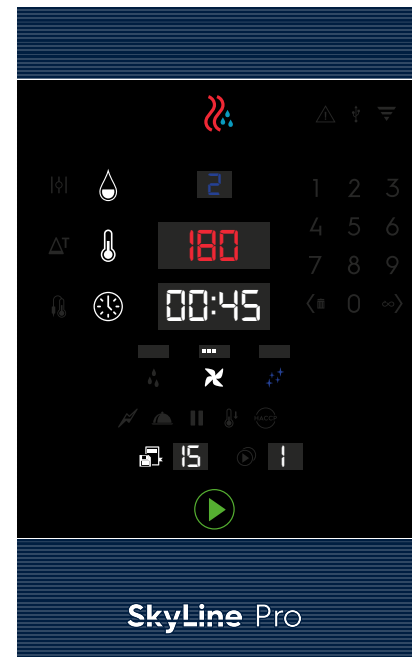

# SkyLine Pro Combi Boilerless Oven

## Digital 6GN1/1 electric



	227920	227910
Number of grids	6	5
Runner pitch - mm	67	85
External dimensions - mm		
width	867	867
depth	775	775
height	808	808
Electric power - kW	11.5	11.8
Electric amperage - A	15.6	17
Electrical connection	440V 3 50/60 H	380-415V 3 50/60 Hz
USPHS	•	•

# SkyLine Pro Combi Boilerless Oven

## Digital 6GN2/1 electric



	227921	227911
Number of grids	6	6
Runner pitch - mm	67	67
External dimensions - mm		
width	1090	1090
depth	971	971
height	808	808
Electric power - kW	22.3	22.9
Electric amperage - A	29.6	32.1
Electrical connection	440V 3 50/60 H	380-415V 3 50/60 Hz
USPHS	•	•

# SkyLine Pro Combi Boilerless Oven

## Digital 10GN1/1 electric



	227922	227912
Number of grids	10	10
Runner pitch - mm	67	85
External dimensions - mm		
width	867	867
depth	775	775
height	1058	1058
Electric power - kW	19.8	20.3
Electric amperage - A	26.0	28.3
Electrical connection	440V 3 50/60 Hz	380-415V 3 50/60 Hz
USPHS	•	•

# SkyLine Pro Combi Boilerless Oven

## Digital 10GN2/1 electric



	227923	227913
Number of grids	10	10
Runner pitch - mm	67	67
External dimensions - mm		
width	1090	1090
depth	971	971
height	1058	1058
Electric power - kW	36.9	37.9
Electric amperage - A	48.2	52.4
Electrical connection	440V 3 50/60 Hz	380-415V 3 50/60 Hz
USPHS	•	•





# SkyLine Ovens Accessories Range Overview

<b>Cooking solutions</b>	<b>30</b>
GastroNorm trays	30
Bakery / Pastry trays	36
Chicken system	38
Smoker	40
Food Probe	41
<b>Handling solutions</b>	<b>42</b>
GastroNorm handling	45
Banqueting handling	49
Bakery / Pastry handling	50
Bakery / Pastry fixed racks	52
Multipurpose fixed racks	52
GastroNorm fixed racks	52
<b>Cleaning solutions</b>	<b>53</b>
Cleaning solutions	53
Water treatment	55
<b>Installation solutions</b>	<b>56</b>
Bases	56
Wall supports	60
Ventilation	61
Stacking kits	67
Miscellaneous	69
<b>Connectivity</b>	<b>73</b>



Accessories  
compatible with  
SkyLine Ovens



Accessories  
compatible with  
Marine solutions

# GastroNorm trays

Cooking solutions

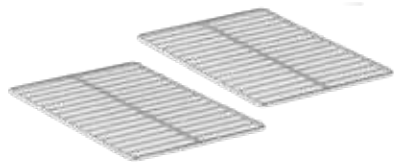

## Grids



Size	GN 1/1	GN 2/1
PNC	922017 (pair) 922062 (single)	922175 (pair) 922076 (single)
Material	AISI 304	

- ▶ Ideal:
  - for roasting large pieces
  - as support for irregular containers and plates to be regenerated



## Meat hook



Oven size	all
PNC	922348
Hook length	300 mm
Material	AISI 304

- ▶ for peking duck or other large pieces of meat
- ▶ maximum weight: 15 kg
- ▶ hook to be hanged on grid tray (922062 or 922076) placed on the top position of the tray rack

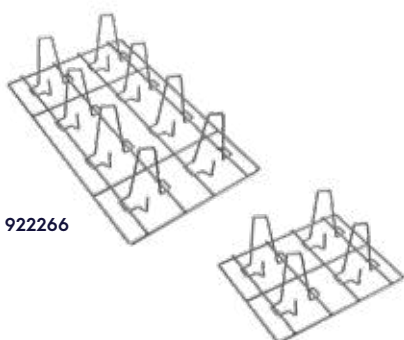

## Chicken grids



Size	GN 1/2				GN 1/1	
PNC	922086 (single)				922036 (pair) 922266 (single)	
Chickens per grid	4 (0,7-2 kg size)				8 (0,7-2 kg size)	
Chicken load	16 on 6 GN1/1	32 on 6 GN2/1	24 on 10 GN1/1	48 on 10 GN2/1	48 on 20 GN1/1	96 on 20 GN2/1
Material	AISI 304					

- ▶ Ideal for obtaining perfect browning and juicy cooking results thanks to the distribution of the chickens in the grid

# GastroNorm trays

Cooking solutions

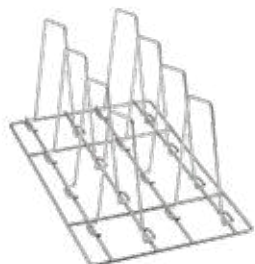

## Duck grid



Size	GN 1/1					
PNC	922362					
Ducks per grid	8 (1,2-2,5 kg size)					
Duck load	8 on 6 GN1/1	16 on 6 GN2/1	16 on 10 GN1/1	32 on 10 GN2/1	32 on 20 GN1/1	64 on 20 GN2/1
Material	AISI 304					

- ▶ Ideal for obtaining perfect browning and juicy cooking results thanks to the distribution of the ducks in the grid



## Grease collection trays with drain lock



Oven size	GN 1/1	GN 2/1
PNC 40mm	922329	
PNC 60 mm		922357
PNC 100 mm	922321	
Material	AISI 304	

- ▶ Ideal for an easy fat collection and drainage thanks to the integrated stainless steel drain
- ▶ Include tray with integrated drain and lid

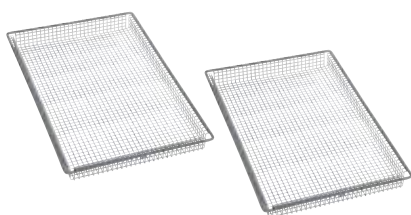

## Cooking baskets



Size	GN 1/1
PNC	922239 (pair)
Material	AISI 304

- ▶ Ideal for
  - steaming
  - air frying frozen pre-fried food (french fries, chicken nuggets, crab sticks, etc.)

# GastroNorm trays

Cooking solutions



## Non-stick U-pans with coating



Size	GN 1/2	GN 1/1
PNC 20 mm	925009	925000 (single) 925012 (6 pcs)
PNC 40 mm	925010	925001 (single) 925013 (6 pcs)
PNC 60 mm	925011	925002 (single) 925014 (6 pcs)
Material	aluminum alloy with non-stick coating	

- ▶ Ideal for:
  - reducing cooking time up to 10% and energy consumption up to 8% (surface preheating is not required; differently from fry tops, the pan can come directly from the refrigerator)
  - reducing food weight loss by 2-4% in comparison with traditional methods, enabling juicier products
  - improving operations (eliminates smoke, heat, necessity to grease the pans and turn food upside down)
- ▶ Recommended to use plastic spatulas in order to extend special coating life
- ▶ Recommended not to clean with granule-type dishwashers

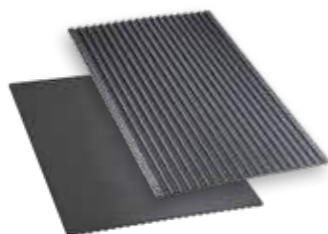

## Double face griddle (ribbed and smooth)



Size	GN 1/1
PNC	925003
Material	aluminum alloy with non-stick coating

- ▶ Ideal for:
  - various cooking needs (double-faced pan features ribbed side for grilling and marking, flat side for baking and toasting)
  - improving operations (no pre-heating needed, eliminates smoke and heat exhaustion, aluminum enhances the heat exchange for faster and more even cooking)
  - baking on smooth side



## Non-stick grill with coating



Size	GN 1/1
PNC	925004
Material	aluminum alloy with non-stick coating

- ▶ Ideal for:
  - marking steaks
  - improving operations (no pre-heating needed)
  - low fat cooking



# GastroNorm trays

Cooking solutions



## Mesh grilling grid



Size	GN 1/1
PNC	922713
Material	aluminum alloy with non-stick coating

- ▶ Ideal for:
  - marking steaks
  - improving operations (no preheating needed)
  - low fat cooking



## Tray for traditional static cooking



Size	GN 1/1
PNC	922746
Height	100 mm
Material	aluminum alloy with non-stick coating

- ▶ Ideal for:
  - braising stewed meat
  - long cooking sauces (like ragù)



## Non-stick egg fryer with coating



Size	GN 1/1
PNC	925005
Material	aluminum alloy with non-stick coating

- ▶ Ideal for:
  - egg automatic cooking program; may be used also for pancakes, hamburgers, omelettes, quiches and other round shaped food
  - improving operations (no preheating needed, aluminum enhances the heat exchange for faster and more even cooking)

# GastroNorm trays

Cooking solutions



## Flat baking tray



Size	GN 1/1
PNC	925006
Material	aluminum alloy with non-stick coating

- ▶ Ideal for:
  - baking bread and pastry



## Non-stick perforated U-pans with coating



Size	GN 1/1
PNC 20 mm	922651
PNC flat	922652
Material	aluminum alloy with non-stick coating

- ▶ Ideal for:
  - dehydrate fruits and vegetables without need of using baking paper
  - baking



## Non-stick baguette tray with coating



Size	GN 1/1
PNC	925007
Material	perforated aluminum, silicon coating

- ▶ Ideal for:
  - baking baguettes (enables fitting 4 pieces, 290 g each)
  - improving operations (perforated aluminum enhances the heat exchange for faster and more even cooking)

# GastroNorm trays

Cooking solutions

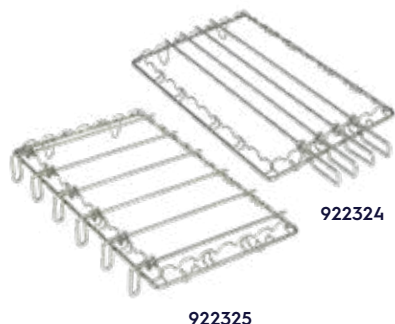

## Universal skewer racks



Size	GN 1/1	GN 2/1
PNC 20 mm	<b>922324</b> (1 rack + 4 long skewers)	<b>922325</b> (1 rack + 6 short skewers)
PNC Long skewer	<b>922327</b> (x4)	
PNC Short skewer		<b>922328</b> (x6)
PNC Rack	<b>922326</b>	
Material	AISI 304	

- ▶ Ideal for preparing all type of kebab, tandoor grill, churrasco, yakitori and any other kind of cooking using skewers (from meat to poultry, to fish, to vegetables and cheese)



## Spit for lamb or suckling pig



Oven size	<b>10 GN 1/1</b>
PNC	<b>922709</b>
Capacity	up to 12 kg
Dimension WxDxH	158x264x600 mm
Material	AISI 304

- ▶ Ideal for:
  - cooking entire sizes of meat using skewer such as kebab, pork, lamb, mutton, porchetta
- ▶ Spit to be fixed on grid tray (922062) placed on the bottom position of the tray rack

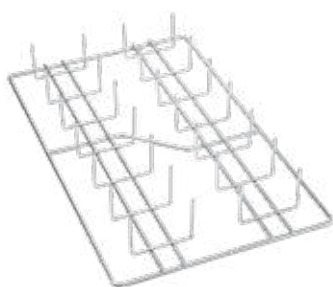

## Potato baker



Size	GN 1/1					
PNC	<b>925008</b>					
Potatoes per grid	28					
Potato load	84	168	140	280	224	448
	6 GN1/1	6 GN2/1	10 GN1/1	10 GN2/1	20 GN1/1	20 GN2/1
Material	AISI 304					

# Bakery / Pastry trays

Cooking solutions



## Grid



Size	400 x 600 mm
PNC	922264*
Material	AISI 304

- ▶ Ideal
  - as a support for 1/1 GN containers without having to replace the tray rack from Bakery to 1/1 GN
  - for cooking with irregularly shaped containers



## Baguette tray



Size	400 x 600 mm
PNC	922189*
Material	perforated aluminum, silicon coated

- ▶ Ideal for
  - baking baguettes (enables fitting 5 pieces, max. 600 mm long)
  - improving operations (perforated aluminum enhances the heat exchange for faster and more even cooking)



## Perforated bakery/pastry tray



Size	400 x 600 mm
PNC	922190*
Material	perforated aluminum

- ▶ Ideal for
  - baking light pastry
  - improving operations (perforated aluminum enhances the heat exchange for faster and more even cooking)



## Smooth bakery/pastry tray



Size	400 x 600 mm
PNC	922191*
Material	aluminum

- ▶ Ideal for:
  - baking breads and pastry
  - improving operations (perforated aluminum enhances the heat exchange for faster and more even cooking)

\* Requires bakery/pastry racks 400 x 600 mm (see pages 51 and 52)

# Bakery / Pastry trays

Cooking solutions



## Double face griddle (ribbed and smooth)



Oven size	400 x 600 mm
PNC	922747*
Material	aluminum alloy with non-stick coating

- ▶ Ideal for:
  - baking on smooth side
  - various cooking needs (double-faced pan features ribbed side for grilling and marking, flat side for baking and toasting)
  - improving operations (no pre-heating needed, eliminates smoke and heat exhaustion, aluminum enhances the heat exchange for faster and more even cooking)

\* Requires bakery/pastry racks 400 x 600 mm (see pages 51 and 52)

# Chicken system

## Cooking solutions



### Reinforced mobile tray rack

Oven size	10 GN 1/1
PNC	922694

- ▶ Ideal for greasy cooking - with 11 tray guides where the lowest one is suitable for a grease drip tray
- ▶ If used with wheels, slide-in (922610) support is required
- ▶ Includes wheels
- ▶ Recommended to be used with grease collection kit (922619 or 922639)



### GreaseOut - grease collection kit for oven cupboard base with trolley

Oven size	6 GN 1/1	6 GN 2/1	10 GN 1/1	10 GN 2/1
PNC	922619			

- ▶ Trolley with removable handle
- ▶ Opening tap on top frontal panel
- ▶ Easy connection with oven
- ▶ Holder for handle included
- ▶ 2 wheels with brakes
- ▶ 2 tanks of 10 lt each



### GreaseOut - grease collection kit for oven open base

Oven size	6 GN 1/1	6 GN 2/1	10 GN 1/1	10 GN 2/1
PNC	922639 (stainless steel)			
PNC	922438 (heat resistant plastic)			

- ▶ Opening tap on top frontal panel
- ▶ Easy connection with oven
- ▶ 2 tanks of 10 lt each

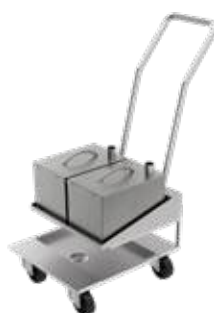

### Extra trolley and tanks for grease collection kit

Oven size	6 GN 1/1	6 GN 2/1	10 GN 1/1	10 GN 2/1
PNC tanks + trolley	922638			
PNC trolley	922752			

- ▶ Ideal for both cupboard base and open base
- ▶ Removable handle
- ▶ Holder for handle included
- ▶ 2 wheels with brakes
- ▶ 2 tanks of 10 lt each (included only in 922638)

Grease collection kit for 6 GN 1/1 stacked ovens and 6 GN 2/1 stacked ovens installed on riser: available as special, to be ordered with the oven.

# Chicken system

Cooking solutions



## Grease collection trays with drain lock



Oven size	GN 1/1	GN 2/1
PNC 40 mm	922329	
PNC 60 mm		922357
PNC 100 mm	922321	
Material	AISI 304	

- ▶ Ideal for an easy fat collection and drainage thanks to the integrated stainless steel drain
- ▶ Include tray with integrated drain and lid

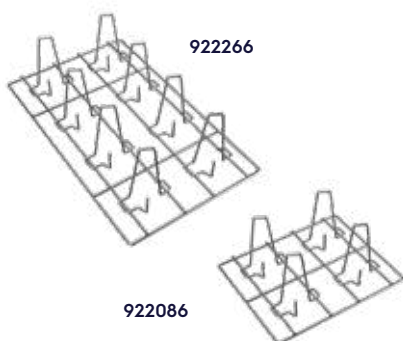

## Chicken grids



Size	GN 1/2		GN 1/1			
PNC	922086 (single)		922036 (pair) 922266 (single)			
Chickens per grid	4 (0,7-2 kg size)		8 (0,7-2 kg size)			
Chicken load	16 on 6 GN1/1	32 on 6 GN2/1	24 on 10 GN1/1	48 on 10 GN2/1	48 on 20 GN1/1	96 on 20 GN2/1
Material	AISI 304					

- ▶ Ideal for obtaining perfect browning and juicy cooking results thanks to the distribution of the chickens in the grid

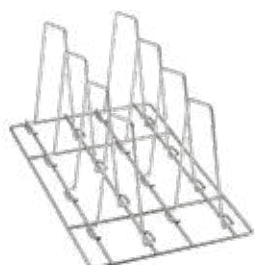

## Duck grid



Size	GN 1/1					
PNC	922362					
Ducks per grid	8 (1,2-2,5 kg size)					
Duck load	8 on 6 GN1/1	16 on 6 GN2/1	16 on 10 GN1/1	32 on 10 GN2/1	32 on 20 GN1/1	64 on 20 GN2/1
Material	AISI 304					

- ▶ Ideal for obtaining perfect browning and juicy cooking results thanks to the distribution of the ducks in the grid

# Smoker

## Cooking solutions



### Volcano smoker

Oven size	6 GN 1/1	6 GN 2/1	10 GN 1/1	10 GN 2/1	20 GN 1/1	20 GN 2/1
PNC	922338					
Material	AISI 304					
Dimension WxDxH	220 X 220 X 85 mm					

- ▶ Ideal for:
  - cooking and smoking of fish, pork, poultry, beef, cheese, bread, vegetables (using wood pellets, dried spices)
  - low temperature cooking with smoked flavour
- ▶ The quantity of smoke produced can be adjusted (registered design @ EPO)
- ▶ Odourless and Condensation hoods are not suitable to be used with Volcano smoker because there is no direct connection to the external exhaust
- ▶ To be used with charcoal



### Wood pellets to be used with Volcano smoker

Code	0S2602	0S2603	0S2604	0S2605	0S2606
Flavor	mesquite	hickory	sugar maple	cherry	apple
Weight	450 g				

- ▶ Mesquite: ideal for ribs, red meat, pork, fish and heavy game
- ▶ Hickory: sweet to strong, heavy bacon flavour. Ideal for pork, ham and beef
- ▶ Sugar maple: smoky, mellow and slightly sweet. Ideal for pork, poultry, cheese, and small game birds
- ▶ Cherry: ideal for poultry, pork and beef
- ▶ Apple: ideal for beef, pork, poultry, fish and game



# Food Probe

## Cooking solutions



### USB single point probe



Oven size	6 GN 1/1	6 GN 2/1	10 GN 1/1	10 GN 2/1	20 GN 1/1	20 GN 2/1
PNC	922390					

- ▶ To be used in addition to the standard core temperature probe
- ▶ Suitable also for high temperature cooking



### USB sous-vide probe



Oven size	6 GN 1/1	6 GN 2/1	10 GN 1/1	10 GN 2/1	20 GN 1/1	20 GN 2/1
PNC	922281					

- ▶ Ideal for sous-vide low temperature cooking to ensure that the correct core temperature is accurately reached without affecting the vacuum in the bag
- ▶ 1 mm in diameter, 60 mm in length, with a special diagonal-cut needle point design to avoid breaking the vacuum seal when inserted
- ▶ To be used with neoprene adhesive strips (code OS1827\*) or valve (code OS2788\*) and vacuum cooking bags (OS2473\*) to avoid breaking the vacuum seal when inserted



### Valve for sous-vide probe



Oven size	6 GN 1/1	6 GN 2/1	10 GN 1/1	10 GN 2/1	20 GN 1/1	20 GN 2/1
PNC	OS2788					

- ▶ It creates a barrier against air, where the probe needle pierces the bag, thus allowing safe detection of the core temperature of vacuum cooked food
- ▶ Suitable for use in cooking and blast chilling processes from -20°C to 130°C
- ▶ Suitable for cooking processes in a bain-marie up to 100°C and in a steam oven up to 130°C







### Sous-vide cooking, what you need:

- USB Sous-vide probe
- Neoprene adhesive strips or valve for sous-vide probe
- Vacuum bags (different sizes)

\* More accessories for sous-vide cooking are available in the Accessories & Consumables Catalogue





# Handling solutions

## Handling solutions - GastroNorm

Oven & Blast Chiller/ Freezer Size	6 GN 1/1	6 GN 2/1	10 GN 1/1	10 GN 2/1	20 GN 1/1	20 GN 2/1
 GastroNorm rack (6-10)* or trolley rack (20)*	<b>922600</b> 65 mm pitch <b>922606</b> 80 mm pitch	<b>922700</b> 65 mm pitch <b>922611</b> 80 mm pitch	<b>922601</b> 65 mm pitch <b>922602</b> 80 mm pitch	<b>922603</b> 65 mm pitch <b>922604</b> 80 mm pitch	<b>922753</b> 63 mm pitch <b>922754</b> 80 mm pitch <b>922683</b> 84 mm pitch	<b>922757</b> 63 mm pitch <b>922758</b> 80 mm pitch <b>922686</b> 84 mm pitch
	 Slide-in support (+ handle) ONLY FOR OVENS	<b>922610</b>	<b>922605</b>	<b>922610</b>	<b>922605</b>	not necessary
 Slide-in support (+ handle) ONLY FOR BLAST CHILLER/ FREEZERS	not available	not available	<b>880564</b>	<b>880563</b>	not necessary	not necessary
 Trolley	<b>922626</b>	<b>922627</b>	<b>922626</b>	<b>922627</b>	not necessary	not necessary

\* Every rack includes wheels





## Handling solutions - Banqueting

Oven & Blast Chiller/ Freezer Size	6 GN 1/1	6 GN 2/1	10 GN 1/1	10 GN 2/1	20 GN 1/1	20 GN 2/1
 Banqueting rack (6-10)* or trolley rack (20)	not available	not available	<b>922648</b> 30 plates, 65 mm pitch <b>922649</b> 23 plates, 85 mm pitch	<b>922650</b> 51 plates, 75 mm pitch	<b>922756</b> 54 plates, 74 mm pitch <b>922763</b> 45 plates, 90 mm pitch	<b>922760</b> 92 plates, 85 mm pitch <b>922764</b> 116 plates, 66 mm pitch
	 Slide-in support (+ handle) ONLY FOR OVENS	not available	not available	<b>922610</b>	<b>922605</b>	not necessary
 Slide-in support (+ handle) ONLY FOR BLAST CHILLER/ FREEZERS	not available	not available	<b>880564</b>	<b>880563</b>	not necessary	not necessary
 Trolley	not available	not available	<b>922626</b>	<b>922627</b>	not necessary	not necessary
 Thermal blanket	not available	not available	<b>922364</b>	<b>922366</b>	<b>922365</b>	<b>922367</b>



\* Every rack includes wheels

# Handling solutions

## Handling solutions - Bakery/Pastry

Oven & Blast Chiller/ Freezer Size	6 GN 1/1	6 GN 2/1	10 GN 1/1	10 GN 2/1	20 GN 1/1	20 GN 2/1
 Mobile 400x600 mm Bakery/Pastry rack (6-10)*/** or Trolley rack (20)	<b>922607</b> 5 grids, 80 mm pitch	not available	<b>922608</b> 8 grids, 80 mm pitch	<b>922609</b> 8 grids, 80 mm pitch	<b>922761</b> 16 grids, 80 mm pitch	<b>922762</b> 16 grids, 80 mm pitch
 Slide-in support (+ handle) ONLY FOR OVENS	<b>922610</b>	not available	<b>922610</b>	<b>922605</b>	not necessary	not necessary
 Slide-in support (+ handle) ONLY FOR BLAST CHILLER/FREEZERS	not available	not available	<b>880564</b>	<b>880563</b>	not necessary	not necessary
 Trolley	<b>922626</b>	not available	<b>922626</b>	<b>922627</b>	not necessary	not necessary

## Handling solutions - Stacking ovens

Stacked Ovens Size	6 GN 1/1 on 6 GN 1/1	6 GN 2/1 on 6 GN 2/1	6 GN 1/1 on 10 GN 1/1	6 GN 2/1 on 10 GN 2/1
 Mobile racks (6-10): - GastroNorm* - 400x600 mm Bakery/Pastry*/** - Banqueting*  For each oven select one type of rack among the ones listed	TOP OVEN <b>922600 (GN)</b> 65 mm pitch  <b>922606 (GN)</b> 5 grids, 80 mm pitch  <b>922607 (400x600 mm)</b> 5 grids, 80 mm pitch  BOTTOM OVEN <b>922600 (GN)</b> 65 mm pitch  <b>922606 (GN)</b> 5 grids, 80 mm pitch  <b>922607 (400x600 mm)</b> 5 grids, 80 mm pitch	TOP OVEN <b>922700 (GN)</b> 65 mm pitch  <b>922611 (GN)</b> 5 grids, 80 mm pitch  BOTTOM OVEN <b>922700 (GN)</b> 65 mm pitch  <b>922611 (GN)</b> 5 grids, 80 mm pitch	TOP OVEN <b>922600 (GN)</b> 65 mm pitch  <b>922606 (GN)</b> 5 grids, 80 mm pitch  <b>922607 (400x600 mm)</b> 5 grids, 80 mm pitch  BOTTOM OVEN <b>922601 (GN)</b> 65 mm pitch  <b>922602 (GN)</b> 8 grids, 80 mm pitch  <b>922608 (400x600 mm)</b> 8 grids, 80 mm pitch  <b>922648 (30 plates)</b> 65 mm pitch  <b>922649 (23 plates)</b> 85 mm pitch	TOP OVEN <b>922700 (GN)</b> 65 mm pitch  <b>922611 (GN)</b> 5 grids, 80 mm pitch  BOTTOM OVEN <b>922603 (GN)</b> 65 mm pitch  <b>922604 (GN)</b> 8 grids, 80 mm pitch  <b>922609 (400x600 mm)</b> 8 grids, 80 mm pitch  <b>922650 (51 plates)</b> 75 mm pitch
 Slide-in support (+ handle)	2 pcs x <b>922610</b>	2 pcs x <b>922605</b>	2 pcs x <b>922610</b>	2 pcs x <b>922605</b>
 Trolley	<b>922630</b> or <b>922628</b> (On Riser)	<b>922631</b> or <b>922629</b> (On Riser)	<b>922630</b>	<b>922631</b>

\* Every rack includes wheels

\*\* When converting to Bakery/Pastry version (400x600 mm) a specific suction wall is suggested. Electrolux Professional recommends to install the correct suction wall in order to guarantee optimal cooking evenness. Suction wall can be purchased at Electrolux Professional Authorized Service Partners.

# Handling solutions

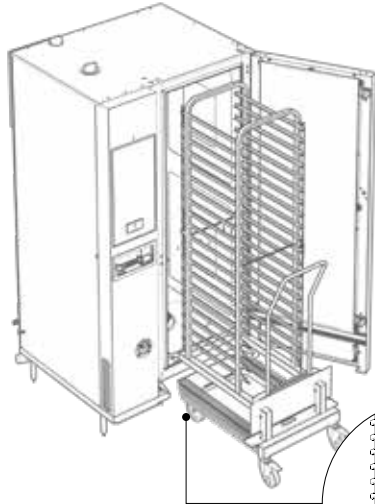

## Kit compatibility for air-o-system trolleys with SkyLine ovens

Oven size	20 GN 1/1	20 GN 2/1
PNC	922769	922770

- ▶ Adaptors to increase the width of the bottom part of the trolleys to perfectly fit in SkyLine ovens
- ▶ Can be installed on GN, Banqueting and Bakery trolleys
- ▶ To be combined with compatibility kit for air-o-system ovens in case of simultaneous use in both SkyLine and air-o-system ovens

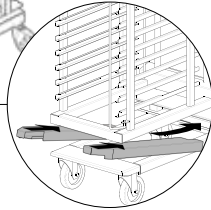

## Kit compatibility for air-o-system ovens with SkyLine trolleys

Oven size	20 GN 1/1	20 GN 2/1
PNC	922771	

- ▶ Spacer kit to expand the roll-in rails placed at the bottom of the air-o-system ovens
- ▶ Can accommodate GN, Banqueting and Bakery trolleys
- ▶ To be combined with compatibility kit for air-o-system trolleys in case of simultaneous use of both SkyLine and air-o-system trolleys
- ▶ Not needed for Blast Chillers

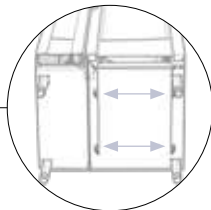

# GastroNorm handling

## Handling solutions



### Slide-in supports

Oven size	6 GN 1/1	6 GN 2/1	10 GN 1/1	10 GN 2/1
PNC for oven	922610	922605	922610	922605
PNC for blast chiller			880564	880563

- ▶ Ideal for easy and safe loading and unloading of mobile rack
- ▶ Include handle
- ▶ Required when using mobile rack
- ▶ Slide-in support for **air-o-system oven** to be ordered as a spare part



### Trolley for mobile racks

Oven size	6 GN 1/1	6 GN 2/1	10 GN 1/1	10 GN 2/1
PNC	922626	922627	922626	922627
Dimension WxDxH	485x913x949 mm	685x1033x949 mm	485x913x949 mm	685x1033x949 mm

- ▶ Ideal for smooth handling process
- ▶ Recommended to be used with slide-in support
- ▶ Trolley for stacking solution available
- ▶ Compatible with **air-o-system ovens**. Slide-in support for air-o-system oven to be ordered as a spare part



### Mobile GastroNorm racks

Oven size	6 GN 1/1	
PNC	922600	922606
Grid nr.	6 grids (65 mm pitch)	5 grids (80 mm pitch)
Dimension WxDxH	389x508x462 mm	

- ▶ Include wheels and base supports
- ▶ If used with wheels, slide-in support is required
- ▶ If used with base support it becomes a fixed rack
- ▶ Compatible with **air-o-system ovens**. Slide-in support for air-o-system oven to be ordered as a spare part

# GastroNorm handling

## Handling solutions



### Mobile GastroNorm racks

Oven size	6 GN 2/1	
PNC	922700	922611
Grid nr.	6 grids (65 mm pitch)	5 grids (80 mm pitch)
Dimension WxDxH	594x628x477 mm	

- ▶ Include wheels and base supports
- ▶ If used with wheels, slide-in support is required
- ▶ If used with base support it becomes a fixed rack
- ▶ Compatible with **air-o-system ovens**. Slide-in support for air-o-system oven to be ordered as a spare part



### Mobile GastroNorm racks

Oven size	10 GN 1/1	
PNC	922601	922602
Grid nr.	10 grids (65 mm pitch)	8 grids (80 mm pitch)
Dimension WxDxH	389x508x723,5 mm	

- ▶ Include wheels and base supports
- ▶ If used with wheels, slide-in support is required
- ▶ If used with base support it becomes a fixed rack
- ▶ Compatible with **air-o-system ovens**. Slide-in support for air-o-system oven to be ordered as a spare part



### Mobile GastroNorm racks

Oven size	10 GN 2/1	
PNC	922603	922604
Grid nr.	10 grids (65 mm pitch)	8 grids (80 mm pitch)
Dimension WxDxH	594x628x723,5 mm	

- ▶ Include wheels and base supports
- ▶ If used with wheels, slide-in support is required
- ▶ If used with base support it becomes a fixed rack
- ▶ Compatible with **air-o-system ovens**. Slide-in support for air-o-system oven to be ordered as a spare part

# GastroNorm handling

## Handling solutions



### GastroNorm trolleys



Oven size	20 GN 1/1		
PNC	922753	922754	922683
Grid nr.	20 grids (63 mm pitch)	16 grids (80 mm pitch)	15 grids (84 mm pitch)
Dimension WxDxH	545x790x1700 mm		

- ▶ Include: removable handle, base with a drain, rear wheels with brakes
- ▶ Compatible with air-o-system
- ▶ For perfect compatibility with **air-o-system** ovens order PNC 922771 (to be installed on the ovens)



### GastroNorm trolleys



Oven size	20 GN 2/1		
PNC	922757	922758	922686
Grid nr.	20 grids (63 mm pitch)	16 grids (80 mm pitch)	15 grids (84 mm pitch)
Dimension WxDxH	716x926x1700 mm		

- ▶ Include: removable handle, base with a drain, rear wheels with brakes
- ▶ Compatible with air-o-system
- ▶ For perfect compatibility with air-o-system ovens order PNC 922771 (to be installed on the ovens)

# Banqueting handling

## Handling solutions



### Slide-in supports

Oven size	6 GN 1/1	6 GN 2/1	10 GN 1/1	10 GN 2/1
PNC for oven	922610	922605	922610	922605
PNC for blast chiller			880564	880563

- ▶ Ideal for easy and safe uploading and downloading of mobile rack
- ▶ Include handle
- ▶ Required when using mobile rack
- ▶ Slide-in support for **air-o-system oven** to be ordered as a spare part



### Trolleys for mobile racks

Oven size	6 GN 1/1	6 GN 2/1	10 GN 1/1	10 GN 2/1
PNC	922626	922627	922626	922627
Dimension WxDxH	485x913x949 mm	685x1033x949 mm	485x913x949 mm	685x1033x949 mm

- ▶ Ideal for smooth handling process
- ▶ Recommended to be used with slide-in support
- ▶ Trolley for stacking solution available
- ▶ Compatible with **air-o-system ovens**. Slide-in support for air-o-system oven to be ordered as a spare part



### Mobile banqueting racks

Oven size	10 GN 1/1	
PNC	922648	922649
Grid nr.	30 plates (65 mm pitch)	23 plates (85 mm pitch)
Dimension WxDxH	391x650x710 mm	

- ▶ Include wheels and base supports
- ▶ Slide-in support is required
- ▶ Plates up to 310 mm Ø
- ▶ Compatible with **air-o-system ovens**. Slide-in support for air-o-system oven to be ordered as a spare part



# Banqueting handling

## Handling solutions



### Mobile banqueting racks

Oven size	10 GN 2/1
PNC	922650
Grid nr.	51 plates (75 mm pitch)
Dimension WxDxH	596x780x702 mm

- ▶ Includes wheels and base supports
- ▶ Slide-in support is required
- ▶ Plates up to 310 mm Ø
- ▶ Compatible with **air-o-system ovens**. Slide-in support for air-o-system oven to be ordered as a spare part

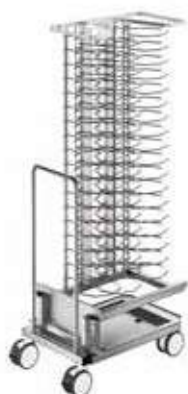

### Banqueting trolleys



Oven size	20 GN 1/1	
PNC	922756	922763
Grid nr.	54 plates (74 mm pitch)	45 plates (90 mm pitch)
Dimension WxDxH	507x849x1714 mm	

- ▶ Include: removable handle, base with a drain, rear wheels with brakes
- ▶ Plates up to 310 mm Ø
- ▶ For perfect compatibility with air-o-system ovens order PNC 922771 (to be installed on the ovens)

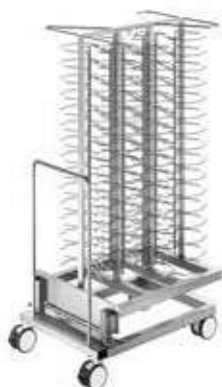

### Banqueting trolleys



Oven size	20 GN 2/1	
PNC	922760	922764
Grid nr.	92 plates (85 mm pitch)	116 plates (66 mm pitch)
Dimension WxDxH	700x986x1711 mm	

- ▶ Include: removable handle, base with a drain, rear wheels with brakes
- ▶ Plates up to 310 mm Ø
- ▶ For perfect compatibility with air-o-system ovens order PNC 922771 (to be installed on the ovens)

# Banqueting handling

## Handling solutions



### Thermal blankets for racks

Oven size	10 GN 1/1	10 GN 2/1
PNC	922364	922366

- ▶ Ideal for keeping food warm up to 30 minutes
- ▶ Enable easy folding with straps
- ▶ Washable: ETL Sanitation approved



### Thermal blankets for trolleys

Oven size	20 GN 1/1	20 GN 2/1
PNC	922365	922367

- ▶ Ideal for keeping food warm up to 30 minutes
- ▶ Enable easy folding with straps
- ▶ Washable: ETL Sanitation approved

# Bakery / Pastry handling

## Handling solutions



### Slide-in supports

Oven size	6 GN 1/1	6 GN 2/1	10 GN 1/1	10 GN 2/1
PNC for oven	922610	922605	922610	922605
PNC for blast chiller			880564	880563

- ▶ Ideal for easy and safe uploading and downloading of mobile rack
- ▶ Include handle
- ▶ Required when using mobile rack
- ▶ Slide-in support for **air-o-system oven** to be ordered as a spare part

# Bakery / Pastry handling

## Handling solutions



### Trolleys for mobile racks

Oven size	6 GN 1/1	6 GN 2/1	10 GN 1/1	10 GN 2/1
PNC	922626	922627	922626	922627
Dimension WxDxH	485x913x949 mm	685x1033x949 mm	485x913x949 mm	685x1033x949 mm

- ▶ Ideal for smooth handling process
- ▶ Recommended to be used with slide-in support
- ▶ Trolley for stacking solution available
- ▶ Compatible with **air-o-system** ovens. Slide-in support for air-o-system oven to be ordered as a spare part



### Mobile bakery/pastry racks (400x600 mm)\*

Oven size	6 GN 1/1	10 GN 1/1	10 GN 2/1
PNC	922607	922608	922609
Grid nr.	5 trays (80 mm pitch)	8 trays (80 mm pitch)	
Dimension WxDxH	428x608x471 mm	428x608x719 mm	

- ▶ Include wheels and base supports
- ▶ If used with wheels, slide-in support is required
- ▶ If used with base support it becomes a fixed rack
- ▶ Compatible with **air-o-system** ovens. Slide-in support for air-o-system oven to be ordered as a spare part



### Bakery/Pastry trolleys (400x600 mm)\*



Oven size	20 GN 1/1	20 GN 2/1
PNC	922761	922762
Grid nr.	16 trays (80 mm pitch)	
Dimension WxDxH	544x841x1695 mm	716x929x1695 mm

- ▶ Include removable handle, bottom tank with a drain, rear wheels with brakes
- ▶ For perfect compatibility with air-o-system ovens order PNC 922771 (to be installed on the ovens)

\* When converting to Bakery/Pastry version (400x600 mm) a specific suction wall is suggested (only for 6 & 10 GN1/1 gas and 20 GN 1/1 electric models). Electrolux Professional recommends to install the correct suction wall in order to guarantee optimal cooking evenness. Suction wall can be purchased at Electrolux Professional Authorized Service Partners.

# Bakery / Pastry fixed racks

Handling solutions

922655



## Fixed bakery/pastry racks 400x600 mm\*

Oven size	6 GN 1/1	10 GN 1/1
PNC	922655	922656
Grid nr.	5 grids (80 mm pitch)	8 grids (80 mm pitch)

# Multipurpose fixed racks

Handling solutions

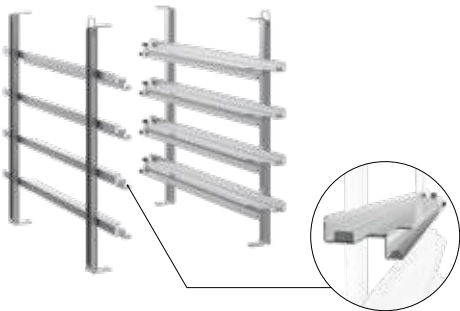

## Multipurpose racks for GN and 400x600 mm



Oven size	6 GN 1/1	10 GN 1/1
PNC	922684	922685
Grid nr.	4 grids (80 mm pitch)	7 grids (80 mm pitch)

- ▶ Fit both GastroNorm and 400x600 mm trays
- ▶ For Bakery/Pastry trays (400x600 mm) a specific suction wall is suggested. Suction wall can be purchased at Electrolux Professional Authorized Service Partners

# GastroNorm fixed racks

Handling solutions

922740



## GastroNorm hanging racks / fixed racks with increased pitch

Oven size	6 GN 1/1	6 GN 2/1	10 GN 1/1	10 GN 2/1
PNC	922740	922681	922741	922742
Grid nr.	5 grids (85 mm pitch)	5 grids (85 mm pitch)	8 grids (85 mm pitch)	8 grids (85 mm pitch)

# Cleaning solutions

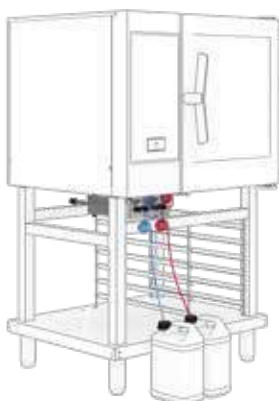

## Connection kit to external liquid chemicals

Oven size	6 GN 1/1	6 GN 2/1	10 GN 1/1	10 GN 2/1	20 GN 1/1	20 GN 2/1
PNC	922618					

- ▶ Kit for use automatic cleaning system with liquid detergent and rinse aid
- ▶ Fast and easy installation on-site
- ▶ Equipped with magnets
- ▶ Kit includes pumps, pipes and connections to the tanks



## Wall mounted holder for detergent tank

Oven size	6 GN 1/1	6 GN 2/1	10 GN 1/1	10 GN 2/1	20 GN 1/1	20 GN 2/1
PNC	922386					

- ▶ Ideal to keep detergents away from the floor
- ▶ Compatible with OS2282, OS2283



## Open base hanging holder for detergent tank

Oven size	6 GN 1/1	6 GN 2/1	10 GN 1/1	10 GN 2/1
PNC	922699			

- ▶ Ideal to keep detergents away from the floor
- ▶ Compatible with OS2282, OS2283



## External spray unit

Oven size	6 GN 1/1	6 GN 2/1	10 GN 1/1	10 GN 2/1	20 GN 1/1	20 GN 2/1
PNC	922171					

- ▶ Includes a support to be mounted on the external side panel of the oven

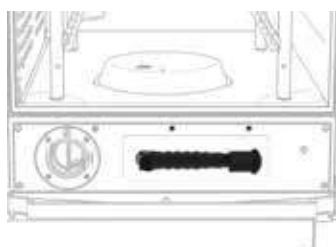

## Retractable built-in spray unit for Premium<sup>S</sup>, Pro

Oven size	6 GN 1/1	6 GN 2/1	10 GN 1/1	10 GN 2/1	20 GN 1/1	20 GN 2/1
PNC	0CK749				Available as factory fitted	

- ▶ Table-top ovens: suggested as factory fitted, can also be installed on-site
- ▶ Vertical ovens: to be ordered together with the oven, cannot be installed on site
- ▶ Already included in all Premium<sup>S</sup> ovens

# Cleaning solutions

 also Marine compatible

**SkyClean** is an automatic and built-in self cleaning system with **integrated descaling of the steam generator**.

## Solid detergents

Ideal for all type of cooking and demanding sites.



**C22** Cleaning Tab



**Cleaning**

Code	Description
<b>0S2395</b>	C22-Cleaning tab phosphate free; 100 tabs bucket
<b>0S2394</b>	C25-Rinse & Descale tab phosphate free; maleic acid free; 50 tabs bucket



**C25** Rinse & Descale



**Rinse Aid & Descale**

## Liquid detergents

Ideal for sites with medium-high dirt level.



**C20** ExtraStrong detergent for ovens



**C21** ExtraStrong Rinse aid for ovens

	Code	Description
<b>Connection kit</b>	<b>922618</b>	External connection kit for liquid detergent/rinse aid
<b>Cleaning</b>	<b>0S2282</b>	C20 ExtraStrong detergent for ovens; 2 x 5l
<b>Rinse Aid</b>	<b>0S2283</b>	C21 ExtraStrong rinse aid for ovens; 2 x 5l

- Water treatment to be performed with dedicated water filters and C25 Rinse&Descale tabs (0S2394) for descaling cycle when needed (see page 55)

## Starter kit

All SkyLine Ovens are delivered with a sample kit of solid detergents. Please, note that when using the sample tabs, double quantity is required for cleaning.  
Example: 1 C22 cleaning tab 65 gr (0S2395) is equal to 2 C22 sample tabs 30 gr.



# Water treatment

## Cleaning solutions



Providing the proper water treatment will:

- ▶ avoid the risk of altering the taste and appearance of your foods
- ▶ reduce scale build-up therefore de-liming is less frequent, thus resulting in additional savings in operating costs
- ▶ extend the life of your appliance
- ▶ guarantee lower maintenance costs

Electrolux Professional suggest you to check your water quality in order to choose the right water treatment solution:

- ▶ water softener for high concentration of calcium
- ▶ water nanofilter or reverse osmosis filter for high concentration of calcium and chloride

## Water requirements

- ▶ Pressure, bar min/max: 1-4.5
- ▶ Supply: Drinking quality water
- ▶ Max temperature supply water : 30°C
- ▶ Hardness:
  - Boiler ovens: no water treatment is required when daily cleaning with C25 Rinse & Descale is performed
  - Boilerless ovens: < 5°fH

- ▶ Chlorides and conductivity:

	304 boiler	316 boiler	boilerless
Chloride	<17	<20	<10
Conductivity	>285	>285	>285

- ▶ Minimum required conductivity of 70 µS/cm



**Automatic water softener**  
PNC 921305

**Oven size:** 6 GN 1/1, 6 GN 2/1,  
10 GN 1/1, 10 GN 2/1, 20 GN 1/1,  
20 GN 2/1

**Power kW:** 0,04

**El. connection:** 220/230V  
1N 50/60 Hz



**External automatic reverse osmosis filter**  
PNC 864388

**Oven size:** 6 GN 1/1, 6 GN 2/1,  
10 GN 1/1, 10 GN 2/1, 20 GN 1/1,  
20 GN 2/1

**Power kW:** 0,18

**El. connection:** 220/240V  
1N 50/60 Hz



**Water filter with cartridge and flow meter**  
PNC 920004

**Oven size:**

6 GN 1/1, 6 GN 2/1 and  
10 GN 1/1 - low use of steam

**Filter capacity:** 4675 lt



**Water filter with cartridge and flow meter**  
PNC 920003

**Oven size:** 10 GN 2/1, 20 GN 1/1,  
20 GN 2/1 - high use of steam

**Filter capacity:** 10800 lt

For more solutions refer to your local presales department.

# Bases

## Installation solutions



922394 Service feet



922351 Marine flanged feet



### Marine configuration on base

To transform a standard base to Marine, it is necessary to replace the standard feet on the base with the Marine flanged feet (delivered with the Marine oven) and then to install the service feet 922394 on the oven



### 4 service feet



Oven size	6 GN 1/1	6 GN 2/1	10 GN 1/1	10 GN 2/1
PNC	922394			
Height	100 mm			
Material	AISI 304			



### Open bases with GastroNorm tray support

Oven size	6 GN 1/1	6 GN 2/1	10 GN 1/1	10 GN 2/1
PNC	922612	922613	922612	922613
Grid nr.	6 (GN 1/1)	6 (GN 2/1)	6 (GN 1/1)	6 (GN 2/1)
Dimensions WxDxH	865x705x770 mm	1088x901x770 mm	865x705x770 mm	1088x901x770 mm
Material	AISI 304			

- ▶ Supplied with 1 tray support as standard, with the possibility to add a second one
- ▶ The bottom of the bases feature holes for assembling
- ▶ Pre-arranged for an easy installation of the ovens (no need to remove feet)
- ▶ When installing on **air-o-system** base, order compatibility kit PNC 930217 for GN1/1 and 930218 for GN2/1



# Bases

## Installation solutions



### Cupboard bases with GastroNorm tray support

Oven size	6 GN 1/1	6 GN 2/1	10 GN 1/1	10 GN 2/1
PNC	922614	922616	922614	922616
Grid nr.	6 (GN 1/1)	6 (GN 2/1)	6 (GN 1/1)	6 (GN 2/1)
Dimensions WxDxH	867x775x770 mm	1090x971x770 mm	867x775x770 mm	1090x971x770 mm
Material	AISI 304			

- ▶ Supplied with 1 tray support as standard, with the possibility to add a second one
- ▶ The bottom of the bases feature holes for assembling
- ▶ Pre-arranged for an easy installation of the ovens (no need to remove feet)
- ▶ When installing on **air-o-system** base, order compatibility kit PNC 930217 for GN1/1 and 930218 for GN2/1
- ▶ for Marine configuration (see page 56)



### GastroNorm tray supports for oven base

Oven size	6 GN 1/1	6 GN 2/1	10 GN 1/1	10 GN 2/1
PNC	922690	922692	922690	922692
Grid nr.	6 (GN 1/1)	6 (GN 2/1)	6 (GN 1/1)	6 (GN 2/1)
Material	AISI 304			

- ▶ To be installed on open and cupboard base with the purpose of providing additional storage
- ▶ To be installed using the pre-arranged holes on the bases
- ▶ Non compatible with **air-o-system** bases

# Bases

## Installation solutions



### Bakery/Pastry tray support for oven base (400x600 mm trays)

Oven size	6 GN 1/1	10 GN 1/1
PNC	922702	
Grid nr.	6	
Material	AISI 304	

- ▶ Bakery/Pastry runners for 400 x 600 mm trays (bakery/pastry) on open and cupboard bases
- ▶ Non compatible with **air-o-system** bases



### Hot cupboard bases with multipurpose tray support

Oven size	6 GN 1/1	6 GN 2/1	10 GN 1/1	10 GN 2/1
PNC	922615	922617	922615	922617
Grid nr.	5 (GN 1/1) 6 (400x600)	5 (GN 2/1)	5 (GN 1/1) 6 (400x600)	5 (GN 2/1)
Dimension WxDxH	867x775x770 mm	1090x971x770 mm	867x775x770 mm	1090x971x770 mm
Power	2,5 kW	2,5 kW	2,5 kW	2,5 kW
Electric connection	230V 1N 50 Hz	230V 1N 50 Hz	230V 1N 50 Hz	230V 1N 50 Hz
Material	AISI 304			

- ▶ Ideal for proving and holding
- ▶ Supplied with 1 tray support as standard
- ▶ Pre-arranged for an easy installation of the ovens (no need to remove feet)
- ▶ When installing on **air-o-system** base, order compatibility kit PNC 930217 for GN1/1 and 930218 for GN2/1
- ▶ for Marine configuration (see page 56)

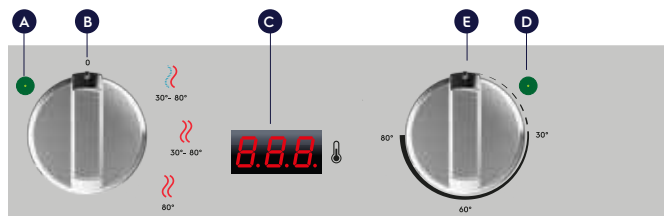

### Control panel description

- A** Indicator lamp showing that the appliance is switched on
- B** Selector for humidifying and heating phases
- C** Digital thermoregulator (30 - 80°C)
- D** Indicator lamp showing that the heating is on
- E** Thermostat for adjusting the chamber temperature

# Bases

## Installation solutions



### Wheels kit for oven bases

Oven size	6 GN 1/1	6 GN 2/1	10 GN 1/1	10 GN 2/1
PNC	922003			

- ▶ Ideal for cleaning behind the oven
- ▶ 2 swivelling wheels with brakes and 2 fixed wheels without brakes
- ▶ If mounted on gas ovens, a flexible pipe is required



### Flanged feet kit



Oven size	6 GN 1/1	6 GN 2/1	10 GN 1/1	10 GN 2/1	20 GN 1/1	20 GN 2/1
PNC	922351				922707	
Height	100-130 mm					
Material	AISI 304					

- ▶ All Marine ovens are delivered with flanged feet as standard
- ▶ Flanged feet can be used for non-Marine ovens



### Disassembled bases

Oven size	6 GN 1/1	10 GN 1/1	6 GN 2/1	10 GN 2/1
PNC	922653		922654	
Dimensions WxDxH	867x707x670 mm		1090x903x670 mm	
Dimensions packaging	750x920x130 mm		940x1140x110 mm	
Material	AISI 304			

- ▶ Delivered disassembled for easier and more convenient transportation
- ▶ Assembly time: less than 10 minutes
- ▶ NO accessory can be installed with the exception of the tray supports for disassembled base (see below)



### Tray supports for disassembled bases

Oven size	6 GN 1/1	10 GN 1/1	6 GN 2/1	10 GN 2/1
PNC	922382		922384	
Grids nr.	4 GN 1/1		4 GN 2/1	

# Wall supports

## Installation solutions



### Wall supports



Oven size	6 GN 1/1	6 GN 2/1	10 GN 1/1
PNC	922643	922644	922645

- ▶ Ideal for space-saving
- ▶ Feasibility of the installation has to be evaluated by an architect/ structural engineer - depending on the type of wall

### Wall fixing kit



Oven size	6 GN 1/1	6 GN 2/1	10 GN 1/1	10 GN 2/1	20 GN 1/1	20 GN 2/1
PNC	922687					

- ▶ To secure the oven to the wall

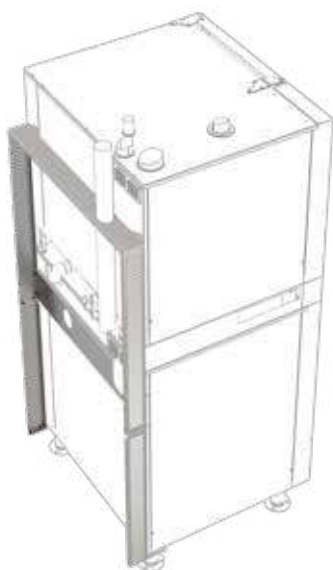

### Marine wall sealing kits



Oven size	6 GN 1/1 on 6 GN 1/1	6 GN 1/1 on 10 GN 2/1	6 GN 2/1 on 6 GN 2/1	6 GN 2/1 on 10 GN 2/1	20 GN 1/1	20 GN 2/1
PNC	922424	922425	922426	922427	922428	922429

- ▶ To seal the Marine ovens to the wall

# Ventilation

## Installation solutions



### Odour reduction hoods

Oven size	6 GN 1/1	6 GN 2/1	10 GN 1/1	10 GN 2/1	20 GN 1/1
PNC	922718	922719	922718	922719	922720
Material	AISI 304				
Note	for electric models only				
Dimension WxDxH	875x1070 x450 mm	1098x1266 x450 mm	875x1070 x450 mm	1098x1266 x450 mm	917x1085 x450 mm

- ▶ Fan motor with 3 automatic speeds
- ▶ Complete ventilation system which eliminates the need for an exhaust duct with external connection
- ▶ Multiple filtration systems: prefiltering of exhaust steam through stainless steel labyrinth filters; demister filter and extra droplets separator acting as a steam-liquid separator
- ▶ UV system attacks the fat molecules eliminating unpleasant odours and bacteria; post-filters restrain the residual odours and no reacted ozone
- ▶ Automatic door opening activation system
- ▶ Double step door opening (PNC 922265) is suggested to improve filtering performance (for table-top only)
- ▶ Possibility to activate air purification system when the oven is in stand by (not cooking) or in cleaning phase
- ▶ Ideal for high temperature cooking or intensive usage



### Odour reduction hoods for stacked ovens

Oven size	6 GN 1/1 on 6 GN 1/1	6 GN 1/1 on 10 GN 1/1	6 GN 2/1 on 6 GN 2/1	6 GN 2/1 on 10 GN 2/1
PNC	922722		922721	
Material	AISI 304			
Note	for electric models only			
Dimension WxDxH	875x1191x450 mm		1098x1266x450 mm	

- ▶ Fan motor with 3 automatic speeds
- ▶ Complete ventilation system which eliminates the need for an exhaust duct with external connection
- ▶ Multiple filtration systems: prefiltering of exhaust steam through stainless steel labyrinth filters; demister filter and extra droplets separator acting as a steam-liquid separator
- ▶ UV system attacks the fat molecules eliminating unpleasant odours and bacteria; post-filters restrain the residual odours and no reacted ozone
- ▶ Automatic door opening activation system
- ▶ Double step door opening (PNC 922265) is suggested to improve filtering performance
- ▶ Possibility to activate air purification system when the oven is in stand by (not cooking) or in cleaning phase
- ▶ Ideal for high temperature cooking or intensive usage

# Ventilation

## Installation solutions



### Condensation hoods

Oven size	6 GN 1/1	6 GN 2/1	10 GN 1/1	10 GN 2/1	20 GN 1/1
PNC	922723	922724	922723	922724	922725
Material	AISI 304				
Note	for electric models only				
Dimension WxDxH	875x1070 x450 mm	1098x1266 x450 mm	875x1070 x450 mm	1098x1266 x450 mm	917x1085 x472 mm

- ▶ Fan motor with 3 automatic speeds
- ▶ Complete ventilation system which eliminates the need for an exhaust duct with external connection
- ▶ Multiple filtration systems: prefiltering of exhaust steam through stainless steel labyrinth filters; demister filter and extra droplets separator acting as a steam-liquid separator
- ▶ Automatic door opening activation system
- ▶ Double step door opening (PNC 922265) is suggested to improve filtering performance (for table-top only)
- ▶ In case of high temperature cooking or intensive usage the Odour Reduction Hood is recommended
- ▶ Condensation hood for 20 GN 1/1 is delivered with a kit for quenching system update (spare part 0CK731) for better steam management



### Condensation hoods for stacked ovens

Oven size	6 GN 1/1 on 6 GN 1/1	6 GN 1/1 on 10 GN 1/1	6 GN 2/1 on 6 GN 2/1	6 GN 2/1 on 10 GN 2/1
PNC	922727		922726	
Material	AISI 304			
Note	for electric models only			
Dimension WxDxH	875x1191x450 mm		1098x1266x450 mm	

- ▶ Fan motor with 3 automatic speeds
- ▶ Complete ventilation system which eliminates the need for an exhaust duct with external connection
- ▶ Multiple filtration systems: prefiltering of exhaust steam through stainless steel labyrinth filters; demister filter and extra droplets separator acting as a steam-liquid separator
- ▶ Automatic door opening activation system
- ▶ Double step door opening (PNC 922265) is suggested to improve filtering performance
- ▶ In case of high temperature cooking or intensive usage the Odour Reduction Hood is recommended

# Ventilation

## Installation solutions

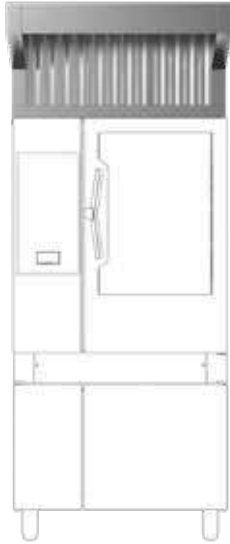

### Standard Hoods (with fan motor)

Oven size	6 GN 1/1	6 GN 2/1	10 GN 1/1	10 GN 2/1	20 GN 1/1
PNC	922728	922729	922728	922729	922730
Material	AISI 304				
Dimension WxDxH	875x1070 x450 mm	1098x1266 450 mm	875x1070 x450 mm	1098x1266 450 mm	917x1085 x450 mm

- ▶ Fan motor with 3 automatic speeds
- ▶ Requires connection to an external exhaust air duct
- ▶ Equipped with a mechanical labyrinth filter
- ▶ Automatic door opening activation system
- ▶ Double step door opening (922265) is suggested to improve filtering performance (for table-top only)



### Standard Hoods (with fan motor) for stacked ovens

Oven size	6 GN 1/1 on 6 GN 1/1	6 GN 1/1 on 10 GN 1/1	6 GN 2/1 on 6 GN 2/1	6 GN 2/1 on 10 GN 2/1
PNC	922732		922731	
Material	AISI 304			
Dimension WxDxH	875x1191x450 mm		1098x1266x450 mm	

- ▶ Fan motor with 3 automatic speeds
- ▶ Requires connection to an external exhaust air duct
- ▶ Equipped with a mechanical labyrinth filter
- ▶ Automatic door opening activation system
- ▶ Double step door opening (922265) is suggested to improve filtering performance

# Ventilation

## Installation solutions

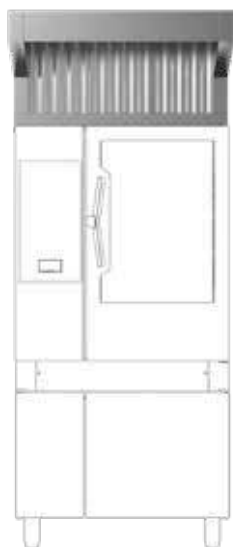

### Hoods without fan motor

Oven size	6 GN 1/1	6 GN 2/1	10 GN 1/1	10 GN 2/1	20 GN 1/1
PNC	922733	922734	922733	922734	922735
Material	AISI 304				
Dimension WxDxH	875x1070 450 mm	1098x1266 450 mm	875x1070 450 mm	1098x1266 450 mm	917x1085 450 mm

- ▶ Requires connection to an external exhaust air duct
- ▶ Equipped with a mechanical labyrinth filter
- ▶ Double step door opening (922265) is suggested to improve filtering performance (for table-top only)

### Hoods without fan motor for stacked ovens

Oven size	6 GN 1/1 on 6 GN 1/1	6 GN 1/1 on 10 GN 1/1	6 GN 2/1 on 6 GN 2/1	6 GN 2/1 on 10 GN 2/1
PNC	922737		922736	
Material	AISI 304			
Dimension WxDxH	875x1191x450 mm		1098x1266x450 mm	

- ▶ Requires connection to an external exhaust air duct
- ▶ Equipped with a mechanical labyrinth filter
- ▶ Double step door opening (922265) is suggested to improve filtering performance



# Ventilation

## Installation solutions

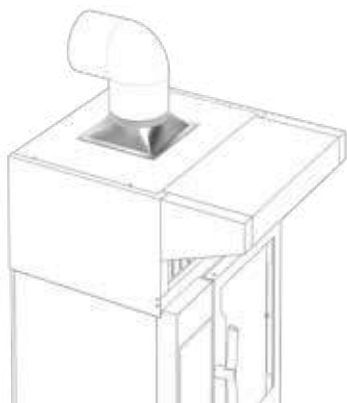

### Hood hopper

Oven size	6 GN 1/1	6 GN 2/1	10 GN 1/1	10 GN 2/1	20 GN 1/1
PNC	922751				
Dimension WxDxH	360x360x100 mm				

- ▶ Ideal to directly connect the hood to the centralized ventilation system
- ▶ Only for Standard Hoods (with fan motor) and Hoods without fan motor,
- ▶ Available also for stacked ovens



### Riser for 6 GN 1/1 on base with hood

Oven size	6 GN 1/1
PNC	922632
Dimension WxDxH	829x669x390 mm
Material	AISI 304

- ▶ Ideal for raising 6 GN 1/1 oven when placed under dedicated hood (enables more comfortable operation, as it adds over 25 cm in height)



### Flue condenser

Oven size	6 GN 1/1	6 GN 2/1	10 GN 1/1	10 GN 2/1	20 GN 1/1	20 GN 2/1
PNC	922678					
Note	all gas models					
Dimension WxDxH	406x305x255 mm					

- ▶ Ideal for gathering gas and fumes coming out of the oven and exhausting them through a flue

# Ventilation

## Installation solutions



### Extension for condensation tube



Oven size	6 GN 1/1	6 GN 2/1	10 GN 1/1	10 GN 2/1	20 GN 1/1	20 GN 2/1
PNC	922776					
Note	all models					
Extension Height	370 mm					

- ▶ Ideal to convey steam and vapor from the exhaust tube



### Steam optimizer

Oven size	6 GN 1/1	6 GN 2/1	10 GN 1/1	10 GN 2/1
PNC	922750			
Note	all models			
Material	AISI 304			

- ▶ Ideal for improving uniformity of steam distribution with partial load, by retaining vapor in the cavity.
- ▶ Recommended for condensation hood, to be installed on table top ovens

# Stacking kits

## Installation solutions

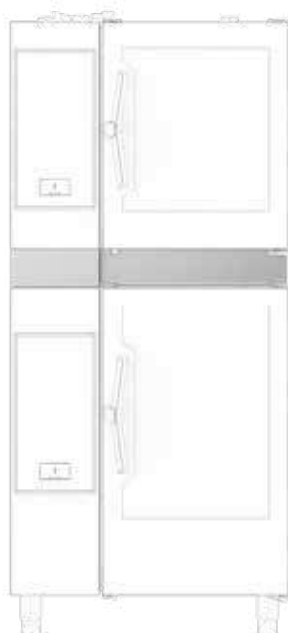

### Stacking kits oven on oven

Oven size	6 GN 1/1 on 6 GN 1/1	6 GN 1/1 on 10 GN 1/1	6 GN 2/1 on 6 GN 2/1	6 GN 2/1 on 10 GN 2/1
PNC	922620 (el.) 922622 (gas)	922620 (el.) 922623 (gas)	922621 (el.) 922624 (gas)	922621 (el.) 922625 (gas)
Dimension WxDxH	867x895x120 mm (el.) 867x895x150 mm (gas)		1090x1092x120 mm (el.) 1090x1092x150 mm (gas)	
Total height installation	electric: 1736 mm	electric: 1986 mm	electric: 1736 mm	electric: 1986 mm
	gas: 1766 mm	gas: 2016 mm	gas: 1766 mm	gas: 2016 mm
Material	AISI 304			

- ▶ Ideal for saving space in the kitchen
- ▶ Include: supports, external panels, flue and water pipes, drain connection and adjustable feet
- ▶ Can be mounted on site
- ▶ Typology (gas, electric) must be ordered considering the oven that will be placed at the bottom
- ▶ 6 GN 1/1 electric oven can be stacked on top of **air-o-system** 6 GN 1/1 electric oven by using compatibility kit PNC 922679 together with stacking kit for **air-o-system** range PNC 922319 (or corresponding spare part)

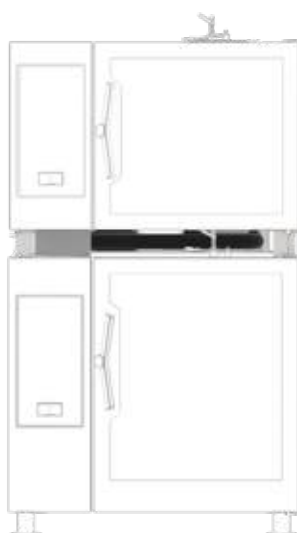

### Marine Stacking kits oven on oven



Oven size	6 GN 1/1 on 6 GN 1/1	6 GN 1/1 on 10 GN 1/1	6 GN 2/1 on 6 GN 2/1	6 GN 2/1 on 10 GN 2/1
PNC	922422	922422	922423	922423
Dimension WxDxH	867x895x150 mm		1090x1092x150 mm	
Total height installation	electric: 1766 mm	electric: 2016 mm	electric: 1766 mm	electric: 2016 mm
	Material			
Material	AISI 304			

- ▶ Ideal for saving space in the kitchen
- ▶ Include: supports, external panels, flue and water pipes, drain connection and adjustable feet
- ▶ Can be mounted on site
- ▶ Typology must be ordered considering the oven that will be placed at the bottom

# Stacking kits

## Installation solutions



### Risers for stacked oven

Oven size	6 GN 1/1 on 6 GN 1/1	6 GN 2/1 on 6 GN 2/1
PNC	922632 (with feet); 922635 (with wheels)	922633 (with feet); 922634 (with wheels)
Dimension WxDxH	829x669x390 mm (feet) 835x675x390 mm (wheels)	1052x865x390 mm (feet) 1058x871x390 mm (wheels)
Material	AISI 304	

- ▶ Ideal for easy cleaning and to raise bottom oven for easier operations



### Wheels for stacked oven

Oven size	6 GN 1/1 on 6 GN 1/1	6 GN 2/1 on 6 GN 2/1	6 GN 1/1 on 10 GN 1/1	6 GN 2/1 on 10 GN 2/1
PNC	922704			
Material	AISI 304			

- ▶ Ideal for cleaning behind the oven
- ▶ 2 swivelling wheels with brakes and 2 fixed wheels without brakes
- ▶ If mounted on gas ovens, a flexible pipe is required



### Trolleys for mobile racks for stacked ovens

Oven size	6 GN 1/1 on 6 & 10 GN 1/1	6 GN 2/1 on 6 & 10 GN 2/1	6 GN 1/1 on 6 GN 1/1	6 GN 2/1 on 6 GN 2/1
PNC	922630	922631	922628 (on riser)	922629 (on riser)
Material	AISI 304			

- ▶ Ideal for easy and safe load and unload of mobile racks on top and bottom ovens
- ▶ Compatible with mobile GastroNorm, Bakery/Pastry and Banqueting racks
- ▶ Trolleys for mobile racks for stacked ovens are compatible with air-o-system ovens

# Miscellaneous

## Installation solutions



### Left hinged door

Oven size	6 GN 1/1	6 GN 2/1	10 GN 1/1	10 GN 2/1
PNC	0CK383			
Family	all			

- ▶ Suggested as factory fitted, can also be replaced on-site



### Double-step door opening



Oven size	6 GN 1/1	6 GN 2/1	10 GN 1/1	10 GN 2/1
PNC	922265			

- ▶ Ideal for increasing operating safety:
  - The first step gradually lets the steam out, without a complete door opening
  - The second step allows a complete door opening
- ▶ All Marine SkyLine ovens are delivered with double-step door opening as standard



### Marine door stopper



Oven size	6 GN 1/1	6 GN 2/1	10 GN 1/1	10 GN 2/1	20 GN 1/1	20 GN 2/1
PNC	922775					
Material	AISI 304					

- ▶ All Marine SkyLine ovens are delivered with door stopper as standard
- ▶ Door stopper can be used for non-Marine ovens

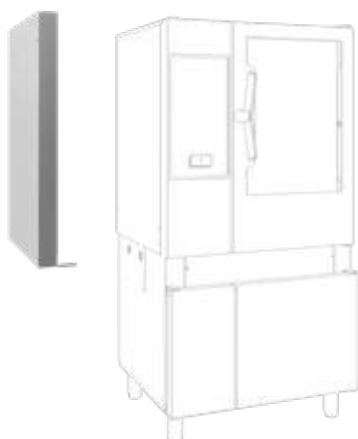

### Heat shields



Oven size	6 GN 1/1	6 GN 2/1	10 GN 1/1	10 GN 2/1	20 GN 1/1	20 GN 2/1
PNC	922662	922665	922663	922664	922659	922658
Family	all					

- ▶ Ideal for protecting left side of the oven (electronics) from overheating caused by closeness to strong heat sources (ex. charbroilers, stoves...)
- ▶ 70 mm thickness

# Miscellaneous

## Installation solutions



### Heat shields for stacked ovens



Oven size	6 GN 1/1 on 6 GN 1/1	6 GN 2/1 on 6 GN 2/1	6 GN 1/1 on 10 GN 1/1	6 GN 2/1 on 10 GN 2/1
PNC	922660	922666	922661	922667
Family	all			

- ▶ Ideal for protecting left side of the oven (electronics) from overheating caused by closeness to strong heat sources (ex. charbroilers, stoves...)
- ▶ 70 mm thickness



### Entry ramps



Oven size	20 GN 1/1	20 GN 2/1
PNC	922715	922716
Material	AISI 304	

- ▶ Ideal for easily and safely inserting and removing the mobile rack to and from the oven in case of unlevelled kitchen floor
- ▶ Suggested with trolley from SkyLine range
- ▶ Mandatory in case of uneven floor. Maximum slope allowed is 1%: 1 mm every 100 mm

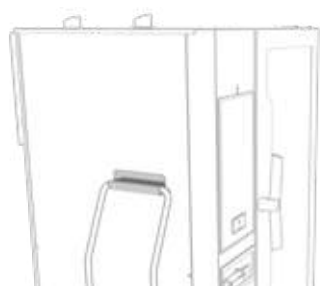

### Holder for trolley handle



Oven size	20 GN 1/1	20 GN 2/1
PNC	922743	
Material	AISI 304	

- ▶ Ideal for hanging the handle of the trolley when the latest is inside the oven

# Miscellaneous

## Installation solutions



### 4 height adjustable feet with black plastic cover kit

Oven size	6 GN 1/1	6 GN 2/1	10 GN 1/1	10 GN 2/1
PNC	922693			
Height	100-115 mm			
Material	AISI 304 and black plastic			



### 4 height adjustable feet kit for 6 & 10 grids ovens

Oven size	6 GN 1/1	6 GN 2/1	10 GN 1/1	10 GN 2/1
PNC	922745			
Height	230-290 mm			
Material	AISI 304			

- ▶ Ideal for cleaning below the oven



### 4 adjustable wheels kit for 20 grids ovens

Oven size	20 GN 1/1	20 GN 2/1
PNC	922701	

- ▶ Ideal for cleaning behind the oven
- ▶ Adjustable height ( $\pm 6$  mm)
- ▶ 2 swivelling wheels with brakes and 2 fixed wheels without brakes
- ▶ If mounted on gas ovens, a flexible pipe is required

# Miscellaneous

## Installation solutions

### Kits to convert from LPG to natural gas and viceversa

Oven size	6 GN 1/1	6 GN 2/1	10 GN 1/1	10 GN 2/1	20 GN 1/1	20 GN 2/1
PNC	<b>922671</b> (LPG to natural gas) <b>922670</b> (Natural gas to LPG)					

- ▶ In case of conversion of 6 GN 1/1 or 6 GN 2/1 ovens from Natural Gas to LPG, also chimney 922706 is needed

### Kit for installation of electric power peak management system

Oven size	6 GN 1/1	6 GN 2/1	10 GN 1/1	10 GN 2/1	20 GN 1/1	20 GN 2/1
PNC	<b>922774</b>				<b>922778</b>	

- ▶ Required to set up equipment for third party power peak management system

### Drain installation kits

Oven size	6 GN 1/1	6 GN 2/1	10 GN 1/1	10 GN 2/1	20 GN 1/1	20 GN 2/1
PNC	<b>922636</b> (AISI304) <b>922637</b> (plastic)				<b>922738</b> (AISI304) <b>922739</b> (plastic)	



# Seamless communication

A world of digital seamless connected solutions that simplify your work and help your business develop.

## OnE Connected

Gives real time access to your appliance from any smart device.

Use it to share recipes and monitor information, such as status, statistics, HACCP data and consumptions. Available for SkyLine Premium<sup>S</sup>, Premium, Pro<sup>S</sup> and Pro Combi Ovens.

## OnE Connected setup

SkyLine Ovens can be connected via Connectivity kit to customer's local router. Once connected, all OnE Connected services are available.

### Connectivity kit 922421



- supports both WiFi  and cable connection 
- one kit for each appliance

Connectivity kit can be ordered as an optional accessory. SkyLine ovens and Blast Chiller/Freezers can also be requested as "connectivity ready" from the factory (connectivity kit already installed).



WiFi or cable connection to local router

#### Note:

1. The use of OnE Connected services requires a license agreement provided by Electrolux Professional.
2. The maximum number of connected appliances supported by a single router depends on the capabilities of the router itself.
3. All components will be installed and commissioned during the installation of the appliances by Electrolux Professional Authorized Service Partners.



# Notes

A series of horizontal dotted lines for writing notes.



Excellence is central to everything we do.  
By anticipating our customers' needs, we strive for  
Excellence with our people, innovations, solutions and services.  
To be the OnE making our customers' work-life easier,  
more profitable – and truly sustainable every day.

Follow us on



[www.electroluxprofessional.com](http://www.electroluxprofessional.com)

## Excellence with the environment in mind

- ▶ The majority of Electrolux Professional Group factories are third-party certified according to ISO (International Organization for Standardization) standards ISO 9001 and ISO 14001, with some sites also certified ISO 5001 and ISO 45001.\*
- ▶ We are focused on developing innovative and sustainable solutions designed for low water, energy and detergent consumptions and reduced emissions.
- ▶ Our products are tailored to human comfort based on ergonomic principles and according to the user's natural workflow, achieving maximum efficiency with minimum effort. We also perform third-party ergonomic certifications on certain products (ERGOCERT).
- ▶ The selection of materials and technologies for our products complies with REACH (Registration, Evaluation, Authorization and Restriction of Chemicals) and RoHS directives (Restriction of Hazardous Substances 2011/65/EU) for the protection of human health and the environment



\*for more details, refer to annual Sustainability Report at: [electroluxprofessionalgroup.com](http://electroluxprofessionalgroup.com)